

**OPEX**<sup>®</sup>



## Sure Sort™ Operator Manual for Version 4.2 Machines

9166900OM-EN-V4.2

Revision 21-05

Original Instructions



Sure Sort™



### WARNING

Read this manual thoroughly before attempting to operate this equipment.  
Keep a current copy for your reference.

© 2017-2021 OPEX<sup>®</sup> Corporation

All rights reserved. This document is provided by OPEX for use by their customers, partners and dealers. No portion of these materials may be reproduced, published, or stored in a database or retrieval system, other than for its intended use without the express, written consent of OPEX Corporation.

---

---

## Contacting OPEX

---

---

### **For technical support:**

OPEX Technical Support  
835 Lancer Drive  
Moorestown, NJ 08057 USA

Americas: 1 800.673.9288 -OR- 856.727.1950

EMEA: +1 800.673.9288

Australia: +1 800.945247

[Service@opex.com](mailto:Service@opex.com)

Please have the model name and serial number of the product ready (see [“Equipment Serial Number Location” on page 117](#)).

### **For other inquiries:**

OPEX<sup>®</sup> Corporation  
305 Commerce Dr.  
Moorestown, NJ 08057-4234 USA

Tel: +1 856.727.1100

Fax: +1 856.727.1955

<https://www.opex.com/>

If you find errors, inaccuracies, or any other issues or concerns with this document, please contact the OPEX Technical Writers via email at:

[GroupTechwriters@opex.com](mailto:GroupTechwriters@opex.com)

For help with opexservice.com website-related issues, please contact the OPEX Web Developers via email at: [GroupWebDev@opex.com](mailto:GroupWebDev@opex.com)

# EU Declaration of Conformity



## EU Declaration of Conformity Sure Sort

This declaration of conformity is issued under the sole responsibility of the manufacturer.

### 1.0 Manufacturer

NAME	OPEX Corporation
ADDRESS	305 Commerce Drive, Moorestown, NJ 08057, USA

### 2.0 Technical File

Technical documentation is compiled in accordance with Part B of Annex VII of the machinery directive. This documentation is available on a reasoned request by appropriate national authority to our authorized representative:

NAME	Andre Bernhardt
ADDRESS	Auf der Lug 8 71726 Benningen am Neckar

### 3.0 Description and identification

Description	Item Sorter
Model	Sure Sort
Serial Number	
Year Manufactured	From 2019

### 4.0 Directives

2006/42/EC	Machinery Directive
2014/53/EU	Radio Equipment Directive
2014/30/EU	Electromagnetic Compatibility Directive

### 5.0 Harmonized Standards used

EN 61000-6-2: 2005	Electromagnetic compatibility (EMC). Generic standards. Immunity for industrial environments
EN 61000-6-4: 2011	Electromagnetic compatibility (EMC) -- Part 6-4: Generic standards - Emission standard for industrial environments
EN 619: 2002+A1:2010	Continuous handling equipment and systems. Safety and EMC requirements for equipment for mechanical handling of unit loads
EN ISO 12100-2:2003	Safety of machinery - Basic concepts, general principles for design - Part 2: Technical principles
EN 60204-1:2006+A1:2009	Safety of machinery. Electrical equipment of machines. General requirements
ETSI EN 300 328 V2.1.1 (2016-11)	Wideband transmission systems; Data transmission equipment operating in the 2,4 GHz ISM band and using wide band modulation techniques; Harmonised Standard covering the essential requirements of article 3.2 of Directive 2014/53/EU
ETSI EN 301 489-1 V1.9.2 (2011-09)	Electromagnetic compatibility and Radio spectrum Matters (ERM); ElectroMagnetic Compatibility (EMC) standard for radio equipment and services; Part 1: Common technical requirements

### 6.0 Technical Standards used

NFPA 79:2018	Electrical Standard for Industrial Machinery
UL 2011:2006	Outline of Investigation for Factory Automation Equipment
CSA C22.2 No. 301-2016	Industrial electrical machinery
UL 61800-5-1 (iBOT only)	Standard for Adjustable Speed Electrical Power Drive Systems: Safety requirements – Electrical, Thermal and Energy

### 7.0 Approval

I, the undersigned, hereby declare that the equipment specified above conforms to the above Directive(s) and Standard(s).

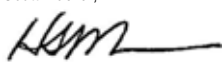
Place of issue	Moorestown, NJ, USA
Date of issue	Feb 19, 2019
Authorized	Scott Maurer, 
Title	President, International Division



## EU Declaration of Conformity Sure Sort

This declaration of conformity is issued under the sole responsibility of the manufacturer.

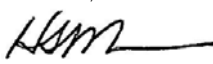
1.0	Manufacturer	NAME	OPEX Corporation
		ADDRESS	305 Commerce Drive, Moorestown, NJ 08057, USA
2.0	Technical File	Technical documentation is compiled in accordance with Part B of Annex VII of the machinery directive. This documentation is available on a reasoned request by appropriate national authority to our authorized representative:	
		NAME	OPEX Business Machines Pty Ltd
3.0	Description and identification	ADDRESS	Level 12, 225 George Street Sydney, NSW 2000 Australia
		Description	Item Sorter
		Model	Sure Sort
		Serial Number	
4.0	Directives	Year Manufactured	From 2019
		2006/42/EC	Machinery Directive
		2014/53/EU	Radio Equipment Directive
5.0	Harmonized Standards used	2014/30/EU	Electromagnetic Compatibility Directive
		EN 61000-6-2: 2005	Electromagnetic compatibility (EMC). Generic standards. Immunity for industrial environments
		EN 61000-6-4: 2011	Electromagnetic compatibility (EMC) -- Part 6-4: Generic standards - Emission standard for industrial environments
		EN 619: 2002+A1:2010	Continuous handling equipment and systems. Safety and EMC requirements for equipment for mechanical handling of unit loads
		EN ISO 12100-2:2003	Safety of machinery - Basic concepts, general principles for design - Part 2: Technical principles
		EN 60204-1:2006+A1:2009	Safety of machinery. Electrical equipment of machines. General requirements
		ETSI EN 300 328 V2.1.1 (2016-11)	Wideband transmission systems; Data transmission equipment operating in the 2,4 GHz ISM band and using wide band modulation techniques; Harmonised Standard covering the essential requirements of article 3.2 of Directive 2014/53/EU
6.0	Technical Standards used	ETSI EN 301 489-1 V1.9.2 (2011-09)	Electromagnetic compatibility and Radio spectrum Matters (ERM); ElectroMagnetic Compatibility (EMC) standard for radio equipment and services; Part 1: Common technical requirements
		NFPA 79:2018	Electrical Standard for Industrial Machinery
		UL 2011:2006	Outline of Investigation for Factory Automation Equipment
		CSA C22.2 No. 301-2016	Industrial electrical machinery
		UL 61800-5-1 (iBOT only)	Standard for Adjustable Speed Electrical Power Drive Systems: Safety requirements – Electrical, Thermal and Energy
7.0	Approval	I, the undersigned, hereby declare that the equipment specified above conforms to the above Directive(s) and Standard(s).	
		Place of issue	Moorestown, NJ, USA
		Date of issue	Feb 19, 2019
		Authorized	Scott Maurer, 
		Title	President, International Division



---

---

## Document History

---

---

Doc Rev	Date	Changes (click blue text to go to that page)
21-05	July 2, 2021	Initial release for Version 4.2 machines.

---

---

## Translation History

---

---

*Table 0-1: Revision History for Translated Manuals*

Source (English version)	Date	Translation Revision	Details (click blue text to go to that page)

### Language Codes:

<b>DE</b>	German
<b>EN</b>	English

<b>ES</b>	Spanish
<b>FR</b>	French

<b>IT</b>	Italian
<b>JA</b>	Japanese

<b>KO</b>	Korean
<b>PL</b>	Polish

---

---

# Table of Contents

---

---

## Chapter 1

### Introduction

1.1. About this Manual .....	10
1.1.1. Manual Navigation Aids .....	11
1.1.2. Safety Message Conventions .....	12

## Chapter 2

### Safety

2.1. Introduction .....	14
2.2. Safety Guidelines .....	15
2.2.1. Consignes de sécurité - traduction française .....	16
2.3. Personal Protective Equipment .....	19
2.4. Ergonomics .....	20
2.5. Emergency Stop Buttons & Interlock System .....	21
2.5.1. Emergency Stop Buttons (E-Stops) .....	21
2.5.2. Interlock System .....	24
2.5.3. Emergency Exit Handle .....	27
2.5.4. Reset Buttons .....	28
2.6. Light Tower .....	29
2.7. Lockout-Tagout (LOTO) Procedures .....	30
2.7.1. What is Lockout-Tagout? .....	30
2.7.2. Lock-Out/Tag-Out Devices Required .....	31
2.7.3. LOTO - Machine Maintenance and Repair .....	33
2.7.4. Fully De-Energizing AC Power .....	36
2.7.5. LOTO - Clearing Jams and Removing iBOTs .....	39
2.7.6. Restoring the Machine to Normal Operation .....	41
2.8. Machine Labels .....	42
2.8.1. Input Conveyor Module Labels .....	43
2.8.2. Return Conveyor Module Labels .....	58

2.8.3. Scan Tunnel Labels .....	62
2.8.4. Base and End Module Labels .....	65
2.8.5. Expansion and End Module Labels .....	76
2.8.6. iBOT Labels .....	84
2.9. Additional Product Safety Information .....	89
2.10. Machine Documentation .....	94

## Chapter 3

### System Overview

3.1. Introduction .....	96
3.2. How the Sure Sort™ Works .....	103
3.2.1. OPEX Host Software .....	104
3.2.2. OPEX Induct ELC .....	105
3.3. Specifications .....	106
3.3.1. Basic Configuration .....	106
3.3.2. Material Handling (Inventory Items) .....	106
3.3.3. Options .....	107
3.3.4. Module Dimensions .....	107
3.3.5. Environmental Specifications .....	108
3.4. Equipment Layout and Required Floor Space .....	109
3.5. Electrical Requirements - North America .....	110
3.6. Electrical Requirements - Europe (EU) .....	111
3.7. Electrical Requirements - Japan .....	112
3.8. Regulatory Compliance Testing .....	113
3.8.1. Standards that Equipment was Evaluated Against .....	113
3.8.2. FCC Standards: .....	114
3.9. Equipment Serial Number Location .....	117

## Chapter 4

### Operation

4.1. Introduction .....	120
4.2. Turning the Power ON/OFF .....	121
4.3. Logging in to the Host Software .....	122

4.4. Navigating the Host Software .....	124
4.4.1. Run Screen Details .....	126
4.4.2. Clearing Jams & Other Warnings .....	129
4.4.3. Product-Related Jams .....	135
4.5. Starting the Machine & Running a Job .....	137
4.5.1. Starting the Machine .....	137
4.5.2. Feeding Items into the Machine .....	138
4.5.3. Scanning Items Manually .....	142
4.6. Stopping the Machine & Exiting the Job .....	145

## Chapter 5

### Statistics

5.1. Introduction .....	148
5.2. Creating Reports .....	148
5.2.1. Setting the Time Range .....	149
5.3. Reject and Jam Definitions .....	150
5.3.1. Rejects .....	150
5.3.2. Jams .....	154
5.3.3. Safety-Related jams .....	159

## Appendix A

### Optional Right-Side (200-Side) Induction

A.1. Introduction .....	164
A.2. E-Stop and Reset Button Locations .....	165
A.3. Equipment Layout and Required Floor Space .....	166
A.4. Right-Side Input Module .....	167

## Chapter G

### Glossary

G.1. List of Acronyms .....	170
G.2. List of Terms .....	171

# 1. Introduction

<b>1.1. About this Manual</b> .....	<b>10</b>
1.1.1. Manual Navigation Aids.....	11
1.1.2. Safety Message Conventions .....	12

**Sure Sort™**

**Operator Manual for Version 4.2 Machines**

---

---

## 1.1. About this Manual

---

---



### WARNING

Read all information thoroughly before attempting to operate this equipment.

This manual contains information about the OPEX Sure Sort automated sorter and its operational procedures and safety-related components, including:

- safety information, safety hazards and precautions
- main component identification and function
- system specifications
- operational and statistical reporting procedures

This information is intended for use by the main operator of the Sure Sort machine. The operator can power up the machine, start a job and feed product onto the conveyor for sorting into bins. Note that the operator is not qualified to perform the following duties (additional training is required for these skill levels):

- **Affected Employee** - An employee whose job requires him or her to operate or use a machine or equipment on which the servicing or maintenance is being performed under lockout or tagout, or whose job requires him/her to work in an area in which such servicing or maintenance is being performed.
- **Authorized Employee** - A person who locks out or tags out machines or equipment in order to perform servicing or maintenance on the machine or equipment.

This manual will be updated to reflect equipment design changes, part number changes, or to correct errors (a table detailing the document revision history can be viewed on [page 5](#)). Be sure to retain the latest electronic release of the manual for your reference. The latest release can be downloaded in PDF format at [www.opexservice.com](http://www.opexservice.com) (authorized, registered users only).

## 1.1.1. Manual Navigation Aids

This manual is designed primarily for use on a tablet device. To improve navigation, the manual contains blue underlined links you can click on or tap to go directly to a particular page or web address. In addition, all items in the [Table of Contents](#) as well as the bookmarks in the side bar of the PDF file can be clicked or tapped to navigate directly to a particular page. Make sure to use the latest version of Adobe<sup>®</sup> Acrobat Reader<sup>®\*</sup> for optimal performance.

\*Adobe and Acrobat Reader are registered trademarks of Adobe Systems Incorporated.

## 1.1.2. Safety Message Conventions

This manual uses the following conventions to alert you about safety hazards associated with certain procedures and situations. Please be aware of these conventions when reading the manual and operating the equipment:



### **DANGER**

Indicates a hazardous situation that, if not avoided, will result in death or severe injury. The use of this signal word is limited to the most extreme situations.



### **WARNING**

Indicates a hazardous situation that, if not avoided, could result in death or serious injury.



### **CAUTION**

Indicates a hazardous situation that, if not avoided, could result in minor or moderate injury.

### **NOTICE**

Indicates information considered important, but not hazard related (e.g. messages relating to property damage).

**Note:** See important safety information in [Chapter 2: "Safety"](#).



# 2

## 2. Safety

<b>2.1. Introduction</b> .....	<b>14</b>
<b>2.2. Safety Guidelines</b> .....	<b>15</b>
2.2.1. Consignes de sécurité - traduction française. ....	16
<b>2.3. Personal Protective Equipment.</b> .....	<b>19</b>
<b>2.4. Ergonomics</b> .....	<b>20</b>
<b>2.5. Emergency Stop Buttons &amp; Interlock System</b> .....	<b>21</b>
2.5.1. Emergency Stop Buttons (E-Stops). ....	21
2.5.2. Interlock System .....	24
2.5.3. Emergency Exit Handle .....	27
2.5.4. Reset Buttons .....	28
<b>2.6. Light Tower</b> .....	<b>29</b>
<b>2.7. Lockout-Tagout (LOTO) Procedures.</b> .....	<b>30</b>
2.7.1. What is Lockout-Tagout? .....	30
2.7.2. Lock-Out/Tag-Out Devices Required. ....	31
2.7.3. LOTO - Machine Maintenance and Repair .....	33
2.7.4. Fully De-Energizing AC Power .....	36
2.7.5. LOTO - Clearing Jams and Removing iBOTs .....	39
2.7.6. Restoring the Machine to Normal Operation .....	41
<b>2.8. Machine Labels</b> .....	<b>42</b>
2.8.1. Input Conveyor Module Labels .....	43
2.8.2. Return Conveyor Module Labels .....	58
2.8.3. Scan Tunnel Labels .....	62
2.8.4. Base and End Module Labels .....	65
2.8.5. Expansion and End Module Labels .....	76
2.8.6. iBOT Labels .....	84
<b>2.9. Additional Product Safety Information</b> .....	<b>89</b>
<b>2.10. Machine Documentation</b> .....	<b>94</b>

**Sure Sort™**

**Operator Manual for Version 4.2 Machines**

---

---

## 2.1. Introduction

---

---

The information provided in this chapter is intended to educate you on various safety issues regarding the operation and maintenance of the OPEX equipment described in this manual.

This chapter describes the following safety-related work practices and measures to protect workers:

- Safety guidelines
- Recommended Personal Protective Equipment (PPE)
- Ergonomic considerations
- Emergency stop buttons and other safety features
- Lock-out/Tag-out procedures
- Identification and location of safety labeling used on the equipment
- Location of equipment documentation



### **WARNING**

Read this chapter thoroughly before using this equipment.

---

---

## 2.2. Safety Guidelines

---

---

This section provides safety guidelines to be observed when working with this equipment.



### WARNING

Follow these safety guidelines whenever operating or maintaining the equipment described in this manual.

**Normal operations** - Only authorized personnel shall start, operate, or interfere with the normal working of the machine. Operator training is required, and training is provided in the “Operation” chapter of the Sure Sort Operator Manual.

**Charging rail** - Hands should be kept clear of the charging rails when the doors are closed. Shorting of the charging rails with either a watch or ring may result in electrical shock.

**Do not remove the plastic, protective covers from the bottom of the iBOTs** - The covers protect the iBOT’s ultracapacitors and circuitry from damage. The covers also protect the operator from harm if the ultracapacitors should leak. For information on ultracapacitor safety, refer to [“Additional Product Safety Information” on page 89](#).

**Standing under an iBOT** - Do not stand under an iBOT while it is carrying a load. No one may remain underneath iBOTS with loads.

**Keep loose objects away from any exposed, moving parts of the machine** - The moving parts of the Sure Sort, such as the conveyor, can become jammed and/or damaged by foreign objects. Keep hands, hair, loose clothing and jewelry away from the moving parts.

**Conveyor systems** - The conveyor system is designed for items that are 5 lbs. (2.27 kg) or less. Do not sit, stand, or travel on any part of the conveyor system while it is in motion.

**Machine Entry** - Do not enter the machine while it is in operation. Only Authorized service maintenance personnel should enter the aisle.

**Machine design** - Do not modify the design or configuration of the equipment without consulting OPEX or your authorized representative.

**Machine Maintenance** - Machine maintenance, particular operations, and all adjustments, whether mechanical or electrical, shall be carried out by persons authorized to do so in accordance with a safe system of work.

**Do not attempt to clean the machine while it is running** - A cloth (or similar material) should never be used to clean moving parts such as belts or rollers. The use of such material on moving mechanisms can result in damage to the machine or severe personal injury. If a belt, roller, gate or similar part needs to be cleaned, hand-crank the part during cleaning or clean it while stationary.

**Do not use flammable, high pressure, “canned air” to clean dust and debris from the machine.**

**Familiarize yourself with the location(s) of machine Emergency Stop switches** - The E-Stop switches enable a quick stop of all motors in the machine, in the event of an emergency involving potential personnel injury. Note that the E-Stops should not be used for normal stopping. For more on proper operations of the machine, refer to [“Operation” on page 119](#).

**Machine access** - Keep all areas around the machine clear of obstacles.

**Keep away from children** - This equipment is not suitable for use in locations where children are likely to be present.

## 2.2.1. Consignes de sécurité - traduction française

**Opérations normales** - Seul le personnel autorisé doit démarrer, opérer ou interférer avec le fonctionnement normal de la machine. La formation de l'opérateur est requise et la formation est fournie dans le manuel de l'opérateur Sure Sort.

**Rail de chargement** - Les mains doivent être éloignées des rails de chargement lorsque les portes sont fermées. Le court-circuit des rails de charge avec une montre ou un anneau peut provoquer un choc électrique.

**Ne retirez pas le plastique, les capots de protection du bas des iBOTs** - Les couvertures protègent les ultracapacités et les circuits des iBOT contre les dommages. Les couvertures protègent également l'opérateur des dommages si les ultracapacités doivent se faufler. Pour plus d'informations sur la sécurité des ultracapaciteurs, reportez-vous à la section "Information produit sur les ultra-condensateurs" à la [page 89](#).

**Debout sous un iBOT** - Ne restez pas sous un iBOT pendant qu'il porte une charge. Personne ne peut rester sous iBOTS avec des charges.

**Gardez les objets lâches à l'écart des parties exposées et mobiles de la machine**

- Les parties mobiles du Sure Sort, telles que le convoyeur, peuvent être bloquées et / ou endommagées par des objets étrangers. Gardez les mains, les cheveux, les vêtements lâches et les bijoux loin des pièces mobiles.

**Systèmes de convoyeur** - Le système de transport est conçu pour les articles de 5 lb. (2,27 kg) ou moins. Ne vous asseyez pas, ne vous tenez pas debout ou ne voyagez pas sur une partie du système de convoyeur lorsqu'il est en mouvement.

**Entrée de la machine** - Ne pas entrer dans la machine pendant son fonctionnement. Seul le personnel d'entretien autorisé doit entrer dans l'allée.

**Conception de la machine** - Ne modifiez pas la conception ou la configuration de l'équipement sans consulter OPEX ou votre représentant autorisé.

**L'entretien des machines** - La maintenance de la machine, les opérations particulières et tous les réglages, qu'ils soient mécaniques ou électriques, doivent être effectués par des personnes autorisées à le faire conformément à un système de travail sûr.

**N'essayez pas de nettoyer la machine pendant son fonctionnement** - Un chiffon (ou un matériau similaire) ne doit jamais être utilisé pour nettoyer les pièces mobiles telles que les courroies ou les rouleaux. L'utilisation d'un tel matériau sur les mécanismes de déplacement peut endommager la machine ou subir des blessures graves. Si une ceinture, un rouleau, une grille ou une pièce similaire doivent être nettoyés, faire manivellez la pièce pendant le nettoyage ou la nettoyer en stationnaire.

**N'utilisez pas d'air comprimé inflammable, à haute pression pour nettoyer la poussière et les débris de la machine.**

**Familiarisez-vous avec le (s) emplacement (s) de la machine Interrupteurs d'arrêt d'urgence**

- Les interrupteurs E-Stop permettent un arrêt rapide de tous les moteurs de la machine, en cas d'urgence impliquant des blessures potentielles du personnel. Notez que les E-Stops ne doivent pas être utilisés pour un arrêt normal. Pour plus d'informations sur le bon fonctionnement de la machine, voir "Fonctionnement" à la Sure Sort Operator Manual.

**Accès à la machine** - Gardez toutes les zones autour de la machine sans obstacles.

**Tenir à l'écart des enfants** - Cet équipement ne convient pas aux endroits où les enfants sont susceptibles d'être présents.

---

---

## 2.3. Personal Protective Equipment

---

---

Personal protective equipment (PPE) refers to wearable safety items such as gloves, safety glasses, hard hats, and high-visibility vests.

Sure Sort falls within Arc Flash PPE Category 1 for Alternating Current (AC) systems. The following PPE items are advised for Arc Flash Category 1:

- Arc-Rated Clothing, Minimum Arc Rating of 4 cal/cm<sup>2</sup> (16.75 J/ cm<sup>2</sup>)
  - Arc-rated long-sleeve shirt and pants or arc-rated coverall
  - Arc-rated face shield or arc flash suit hood
  - Arc-rated jacket, parka, rain wear, or hard hat liner (AN)
- Protective Equipment
  - Hard hat
  - Safety glasses or safety goggles (SR)
  - Hearing protection (ear canal inserts)
  - Heavy-duty leather gloves
  - Leather footwear (AN)

Check with local law and the specific job site to find out what additional PPE is required before starting.

---

---

## 2.4. Ergonomics

---

---

As in any occupation that requires you to perform the same motion repeatedly during the course of your work, it is important to consider how you perform your task. Listed below are some guidelines to help you minimize the risk of physical discomfort and injury while operating the equipment.

**NOTICE**

Always observe the following guidelines when operating the Sure Sort.

**When at the main operator station:**

- Maintain an upright body posture.
- Occasionally change the angle of your posture for greater comfort.
- Avoid operating the machine for longer than a single 10-hour shift. If possible, stretch between breaks.



---

---

## 2.5. Emergency Stop Buttons & Interlock System

---

---

For operator safety, the Sure Sort™ incorporates Emergency-Stop buttons and door interlocks to stop the machine in the event of an emergency.

### 2.5.1. Emergency Stop Buttons (E-Stops)



#### WARNING

Emergency stop switches do not remove power from all electrical devices within the Sure Sort. Power to the computer and other AC devices remains energized after the E-Stop switch is pushed. To remove all power from the machine, follow the [“Lockout-Tagout \(LOTO\) Procedures” on page 30](#).

The big, red, mushroom-shaped Emergency stop (E-stop) buttons can be used to stop the machine in an emergency (see Figure 2-1). One E-Stop is located at the operator station of the Sure Sort, and another behind the return conveyor. If necessary, push one of the E-Stops and the machine will stop immediately.

**Note:** *E-Stops should not be used for normal stopping. For more on proper operations of the machine, refer to the “Operation” chapter of this manual.*



**Figure 2-1: Sure Sort E-Stops**

Aisle E-Stops are located on both sides of the delivery bin modules. Side 100 (left) is closest to the conveyor; side 200 (right) is the far side (see Figure 2-2). At the front left side, the E-Stop is before the first delivery column. On the front right side, the E-Stop is located on the Reject bin enclosure. At the back of the machine, there is an E-Stop on each side after the last delivery column. For machines with 11 expansion modules, E-stops are added mid-aisle to both sides. On the 100 side, E-stop is at column R; on the 200 side, at column Q.

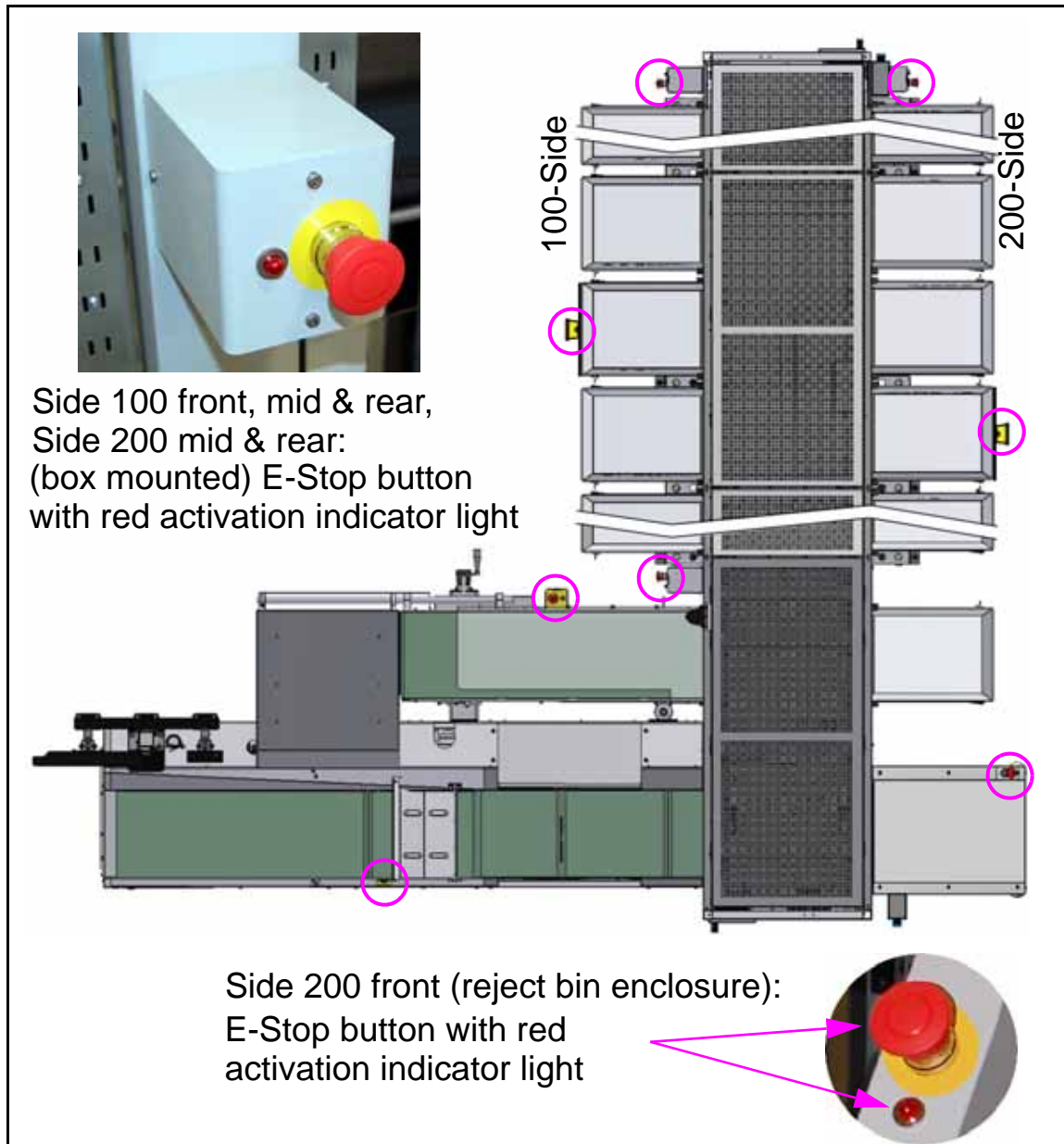

**Figure 2-2: E-Stop Locations, 11-Expansion Module Example**

## 2.5.1.1. Restarting the Machine after an E-Stop Event



### WARNING

Only an Authorized Employee is permitted to perform this procedure.

Once an E-Stop has been pressed, an Authorized Employee will perform the following steps to restart the machine:

1. Inspect the machine to determine the cause of the emergency or accidental stoppage.
2. If repairs are required, lock out/tag out the machine per [“Lockout-Tagout \(LOTO\) Procedures” on page 30](#).
3. Repair the fault, and verify that the machine is safe to operate.
4. Remove all tools and other materials from the area.
5. Ensure the machine is closed up and operationally intact.
6. Notify affected persons that the machine will be restarting.
7. Make sure everyone is safely away from the machine.
8. Pull up on the E-Stop button to deactivate it.
9. If the front and/or rear access door was opened, press the Reset button to reset the interlock.
10. In the Run screen of the host software, clear the jam and restart the machine.

## 2.5.2. Interlock System



### WARNING

Door interlock switches do not remove power from all electrical devices within the Sure Sort. Power to the computer and other AC devices such as power supplies remains energized after an interlock has been opened. To remove all power from the machine, follow the [“Lockout-Tagout \(LOTO\) Procedures”](#) on [page 30](#).

**The operator and any other affected employee should not ever enter the machine.** The Authorized Employee should not enter the machine while it is running, since the rapidly-moving iBOTs can pose a safety hazard. For everyone’s safety, interlocks have been installed on the front and rear door of the Sure Sort™ machine. The interlock system will stop the machine whenever a door is opened. The operator and/or other affected employees should not operate the machine, or plug it in while the machine is tagged out (see Figure 2-3).



Door latch - closed position



Authorized employee has inserted a hasp, lock & tag in the door latch.

**Figure 2-3: Safety Procedure Lockout/Tagout**

### 2.5.2.1. Safety Locking Device & Interlock LED

A safety locking device has been installed to prevent access to the inside of the machine for a delay of six seconds when lifting the door latch to enter the aisle (see Figure 2-4). This delay allows time for all iBOTs to be stopped before the door can be opened.

The lock is an electro-mechanical door lock that uses a solenoid for activation and provides monitoring feedback to the safety controller. This feature allows the system to log events associated with the door being closed or opened and transfers the information to the *OPEX Remote Performance Monitor (RPM)*.

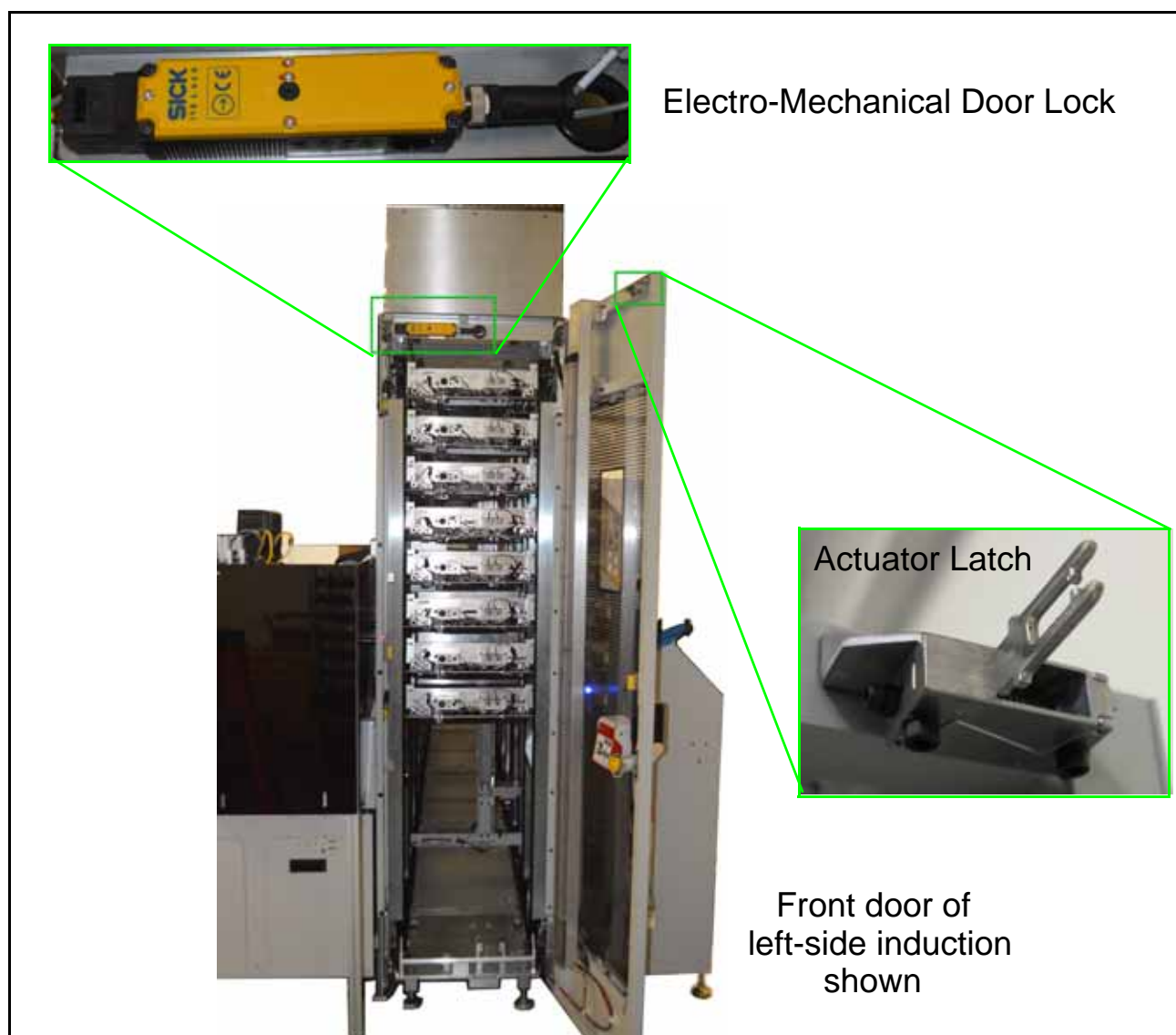

**Figure 2-4: Safety Locking Device**



Once the door is opened, the interlock LED inside the door will be on (see Figure 2-5).



**Figure 2-5: Door Interlock LED**

**Note:** Before the machine can be restarted, an Authorized Employee must confirm that no one is inside the aisle and then push the blue Reset button (see [“Reset Buttons” on page 28](#)).

### 2.5.3. Emergency Exit Handle

An emergency exit handle (egress) is located on the inside of both the front and rear access doors (see Figure 2-6). Simply push the handle to open the door and exit the machine.



**Figure 2-6: Emergency Exit (Egress) Handle**

## 2.5.4. Reset Buttons

Blue Reset buttons are located at the right front and right rear of the machine (see Figure 2-7). The different Reset button labels can be viewed on [page 69](#). Once a door interlock has been opened, the machine will remain disabled and cannot be restarted immediately via the host software. As a safety precaution, an Authorized Employee must visually confirm that no one is inside the aisle and then reset the machine by pushing the Reset button.

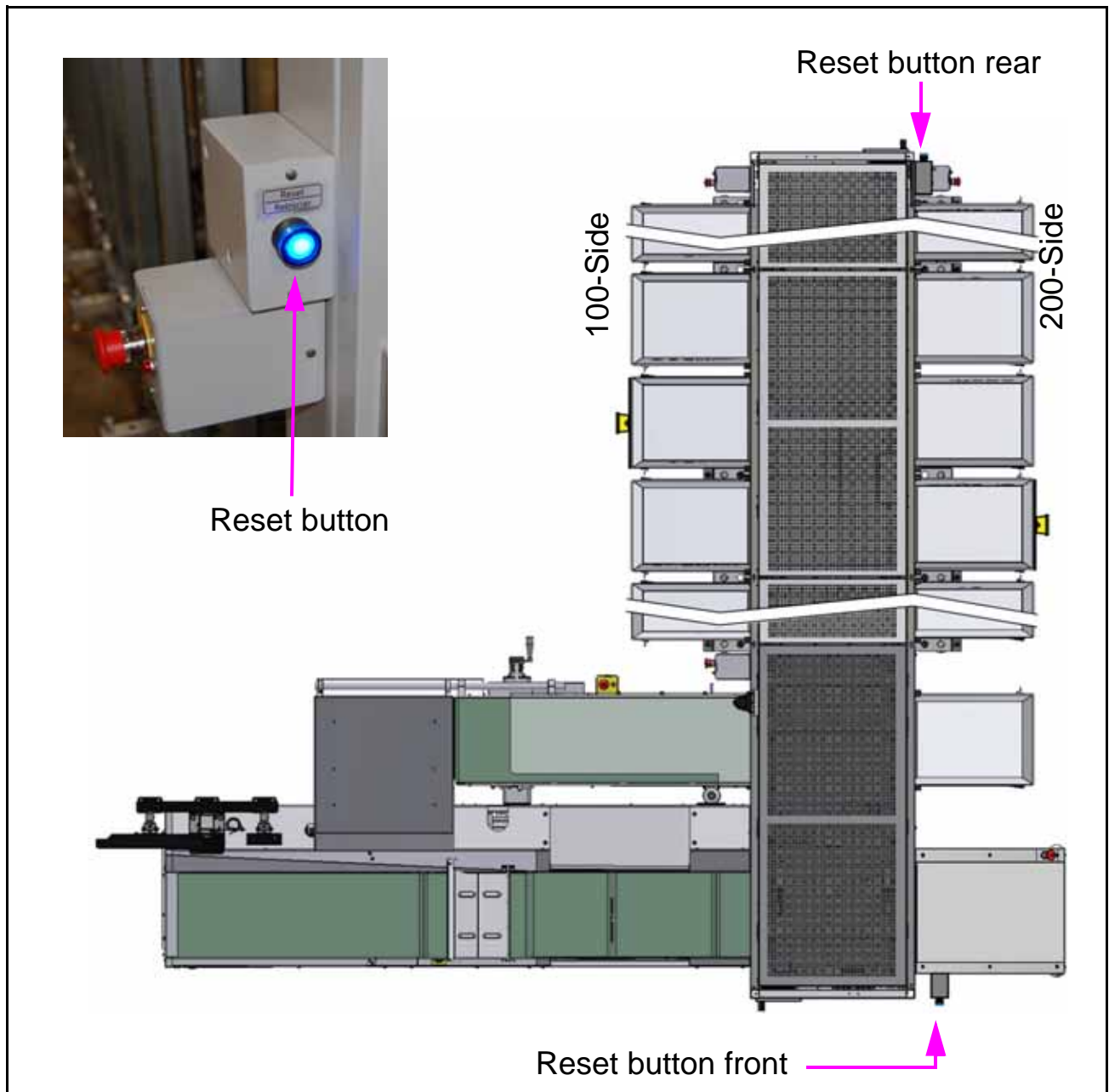
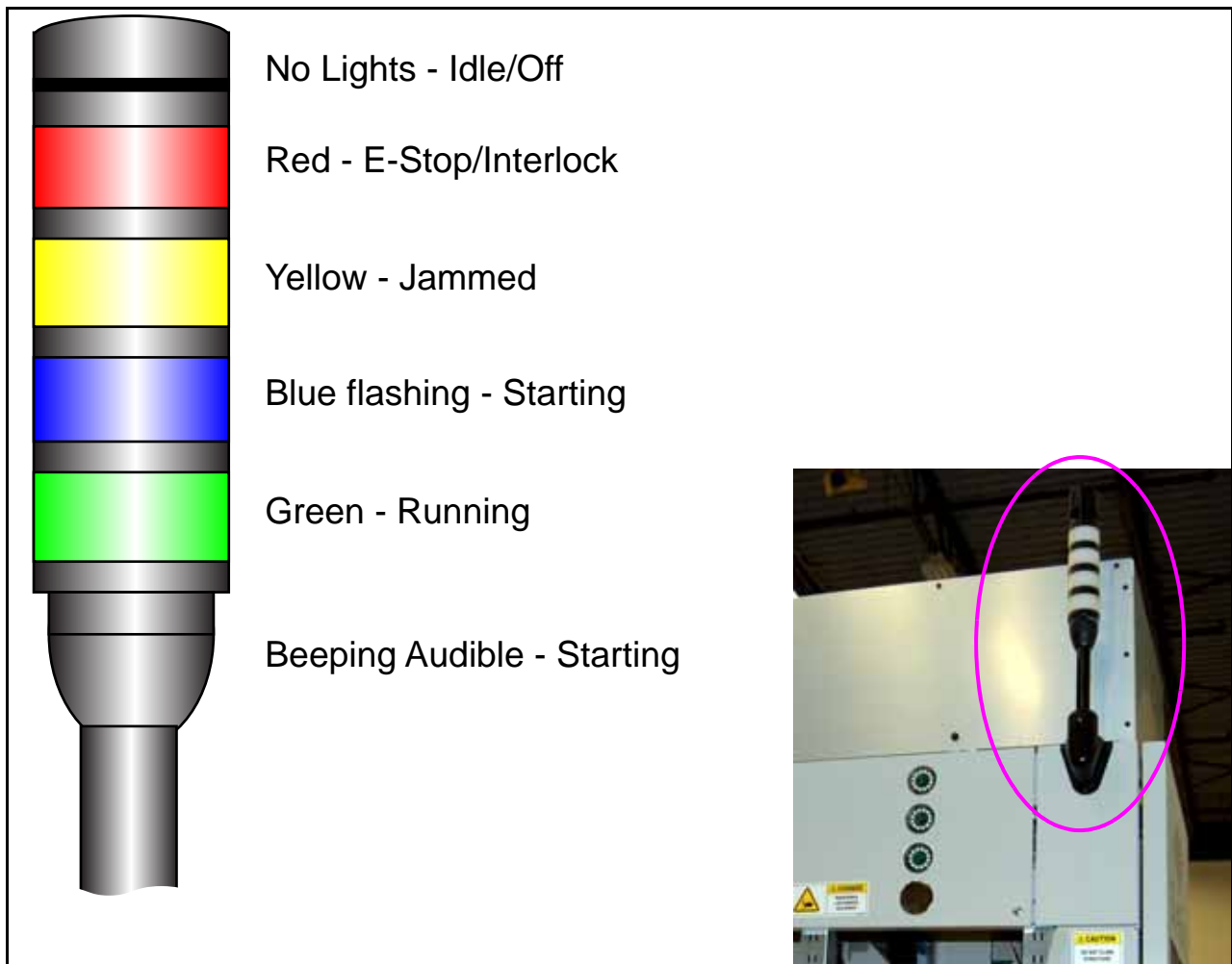

**Figure 2-7: Reset Button Locations**



## 2.6. Light Tower

The light tower is located on the side of the base module. For systems with additional expansion modules, a rear light tower is attached to each side of the end module. The colored bands on the light tower are used to show the status of the machine (see Figure 2-8).



**Figure 2-8: Light Tower Color Coding**

---

---

## 2.7. Lockout-Tagout (LOTO) Procedures

---

---



### WARNING

Only Authorized Employees are permitted to perform the LOTO Procedures. This section is provided for reference only to familiarize operators with the purpose of Lock-out/Tagout and the devices used.

Operators and/or other Affected Employees: Do not attempt to remove or defeat the lockout devices or operate the machine while it is locked out.

### 2.7.1. What is Lockout-Tagout?

Lockout-Tagout (LOTO) is a safety procedure to ensure that a machine is safely shut off and cannot be powered up or operated while maintenance or repair work is performed. During a LOTO event, Authorized service personnel must install locking devices, including padlocks and warning tags, to the machine's power controls, electrical plug or remote electrical disconnect switch (see examples in Figure 2-9). The LOTO devices must only be removed by the Authorized service personnel, once they determine that the work is complete and the machine is safe to operate.

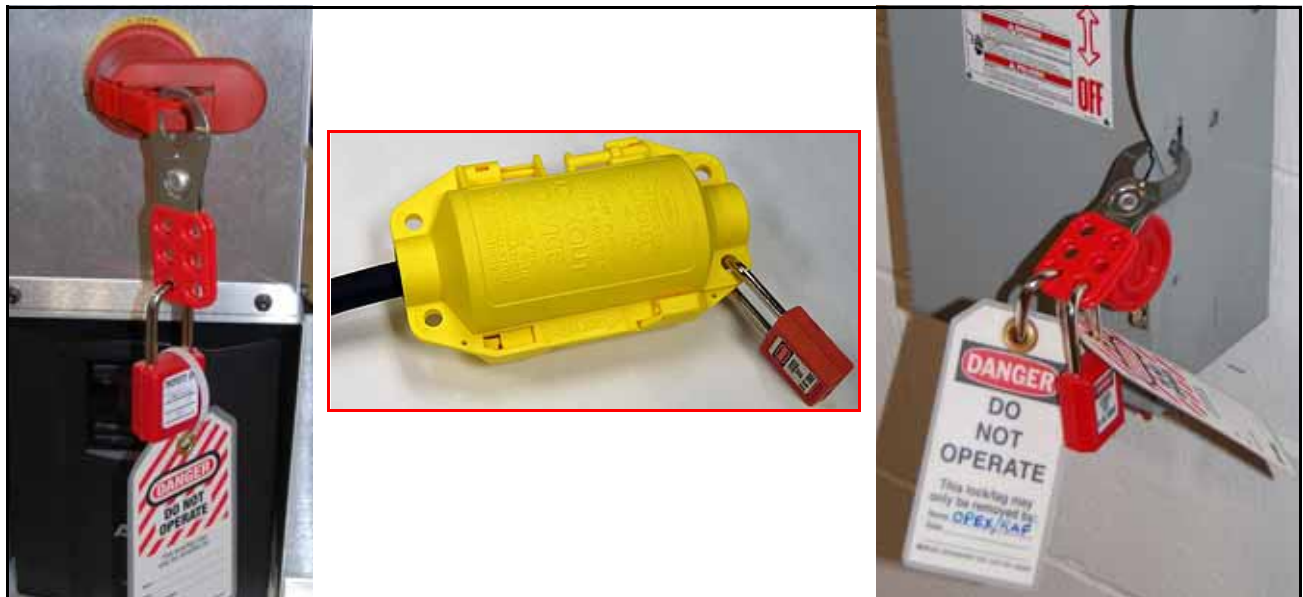

**Figure 2-9: Examples of LOTO Devices Installed**

## 2.7.2. Lock-Out/Tag-Out Devices Required

### 2.7.2.1. Lockout Station

The LOTO procedures require the use of the Lock-Out Station (see Figure 2-10) or an equivalent kit.



*Figure 2-10: Lock-Out/Tag-Out Wall Mount Station*

### 2.7.2.2. Power Cord Lockout Device

**For machines with a power cord plug**, a power cord lockout device (see [Figure 2-11 on page 32](#)) is also required in the event that AC power to the machine must be fully disconnected. Full de-energization of AC power is required in, but not limited to, the following situations:

- machine assembly, dismantling or relocation
- performing maintenance or repairs to the main AC distribution enclosure

The lockout device is placed around the power plug and secured with a padlock to ensure the AC distribution enclosure remains de-energized while work is performed. Two versions of the device are available to match physical plug sizes for North America, EU and Japan.

Installation instructions are located in [“Fully De-Energizing AC Power” on page 36](#).

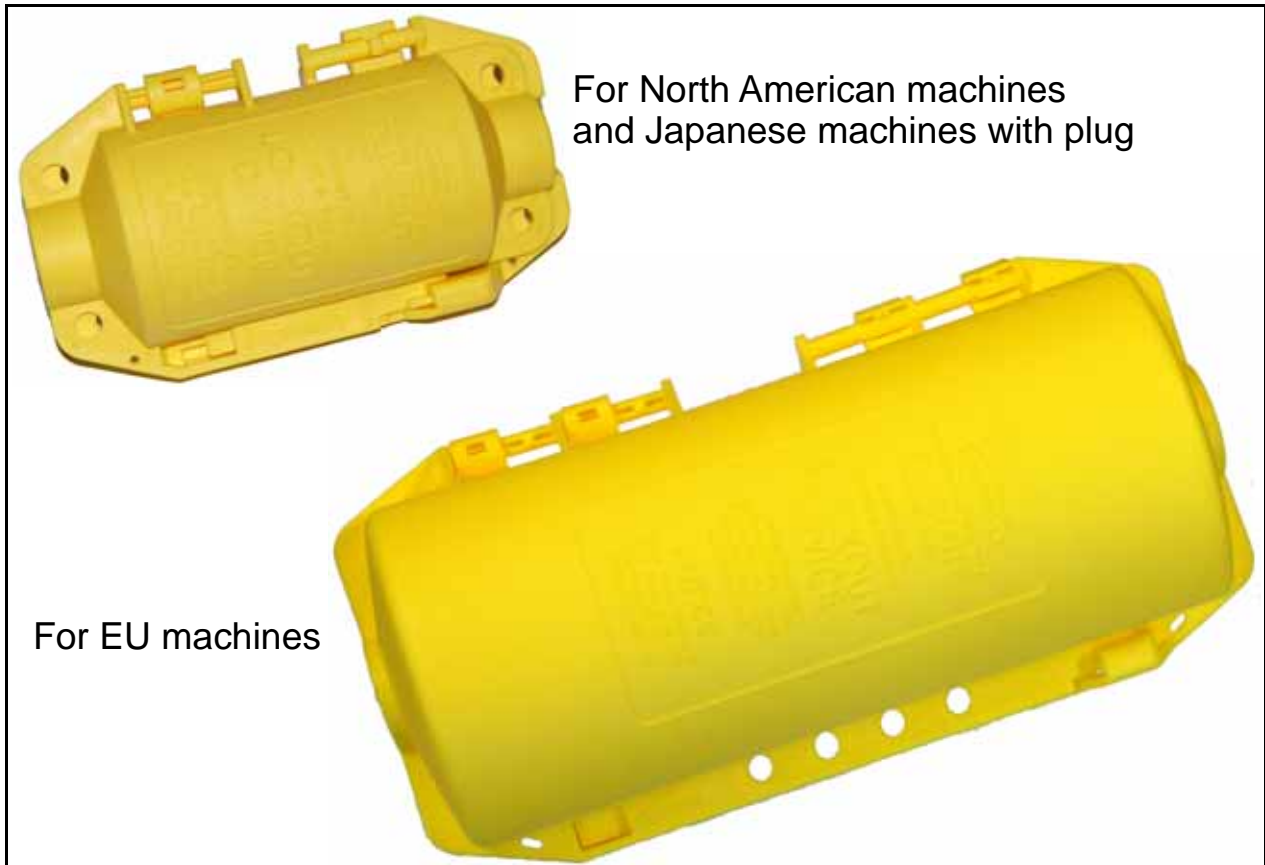

**Figure 2-11: Power Cord Lockout Device**

## 2.7.3. LOTO - Machine Maintenance and Repair

This procedure should only be performed by an Authorized Employee. It describes how to shut down and lock out the Sure Sort when maintenance or repair by an authorized service technician is required.



**DANGER**

Incoming power to the machine's AC Distribution enclosure remains energized when the main disconnect switch is OFF. To fully de-energize the AC Distribution enclosure, an Authorized Employee shall complete all steps in "LOTO - Machine Maintenance and Repair", then disconnect machine from customer's AC power source as follows:

- Plug-in machines, see ["Fully De-Energizing AC Power" on page 36.](#)
- Hard-wired machines, see ["Hard-Wired Machines" on page 38.](#)

**Power down the Sure Sort and install the lockout device as follows:**

1. Notify all personnel that you are about to begin the LOTO procedure.
2. If possible, park the iBOTS.
3. Power down the RTM computer. The RTM computer must be shutdown via remote desktop from the Host computer before powering off the Host computer.
4. Safely shut down the host computer.
5. After the host computer shuts down, manually power down the UPS.
6. Place the "Caution" sign on the monitor (see Figure 2-12).



**Figure 2-12: Caution Sign**

7. Turn the red handle of the main disconnect switch to the OFF position (see Figure 2-13).

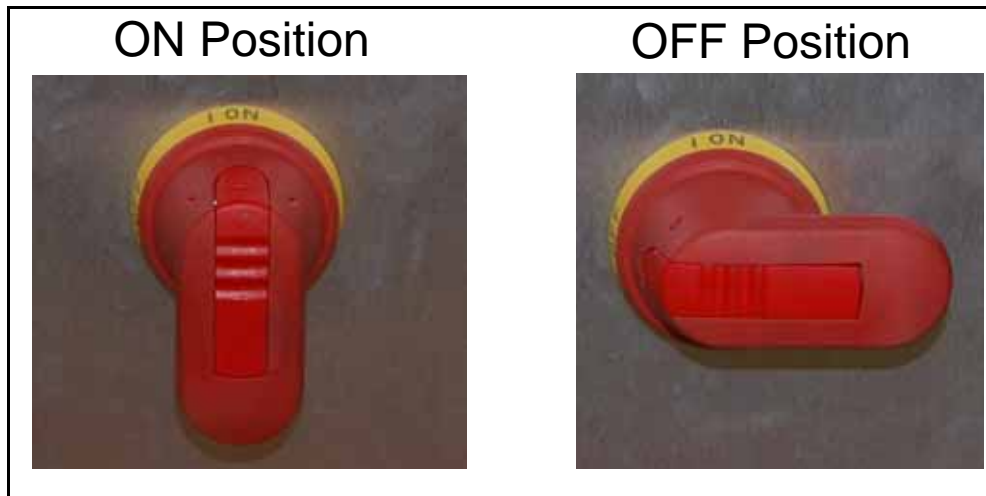

**Figure 2-13: Main Disconnect Switch Handle**

8. Pull the tab out on the main disconnect switch handle and place a hasp through the tab (see Figure 2-14).

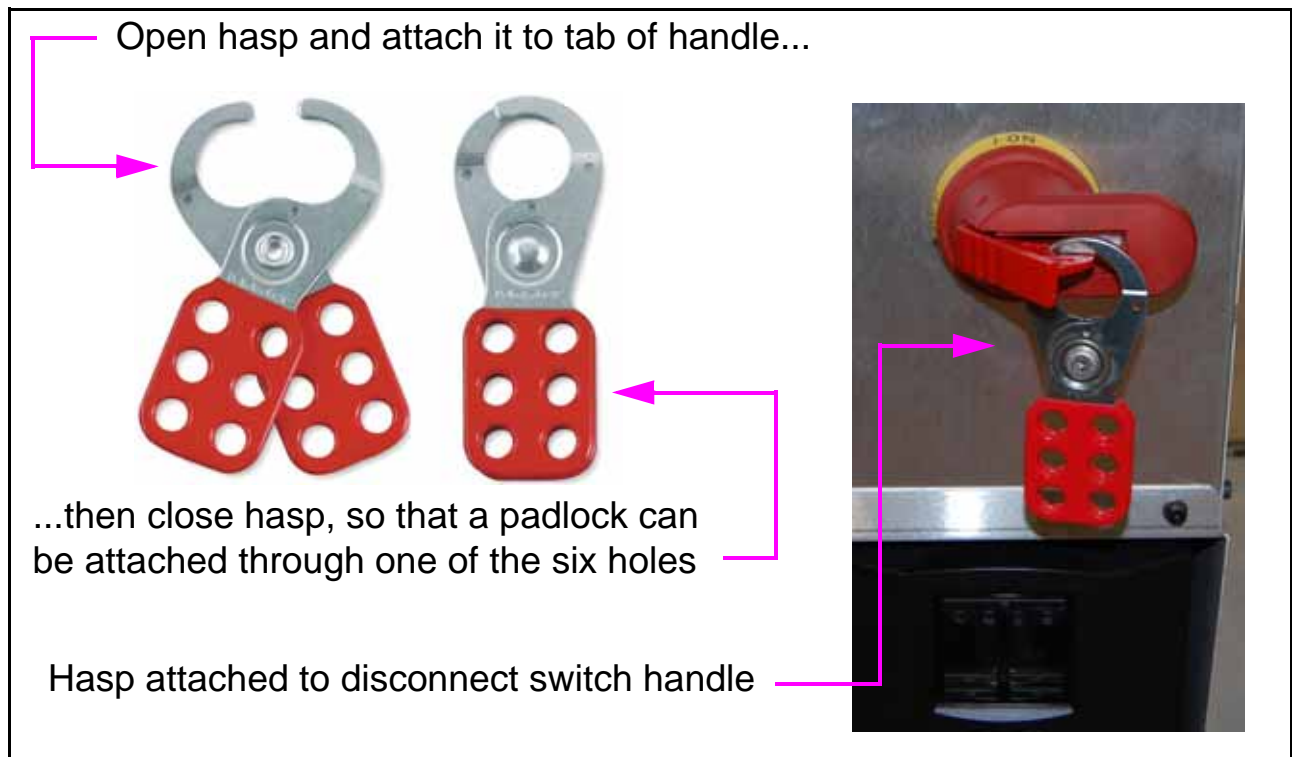

**Figure 2-14: Hasp Detail**



9. Attach a padlock to one of the holes in the hasp. Each Authorized Employee working on the machine must have their own lock, and that lock must have their name on it or an identifying tag that cannot be easily removed or damaged (see Figure 2-15). The key must be kept in the possession of that person.



**Figure 2-15: Lockout Tab with Hasp, Padlock and Tag**

## 2.7.4. Fully De-Energizing AC Power

### 2.7.4.1. Plug-In Machines



#### WARNING

Only an Authorized Employee or qualified electrician is permitted to perform this procedure.

A power cord lockout device (shown in [Figure 2-11 on page 32](#)) is required for this procedure.

To safely de-energize the Sure Sort AC Distribution enclosure, the incoming power must be shut off by disconnecting and locking out the machine's power cord from the customer's AC receptacle. An Authorized Employee or qualified electrician must proceed as follows:

1. Complete all steps under [“LOTO - Machine Maintenance and Repair” on page 33](#).
2. Disconnect the AC main power cord from the receptacle.
3. Install the OPEX lockout device over the AC plug as follows (refer to [Figure 2-16 on page 37](#)):
  - a. Place the AC plug inside the device and close the device. Slide the two halves of the device as directed on the cover to lock them together (refer to the arrows and labels on the device).
  - b. Install the padlock through the loop on the lockout device. Keep the padlock key *on your person* at all times while working on the machine. Additional holes in the lockout device allow for multiple padlocks to be installed.



Device for North American and Japanese machines:



Device for EU machines:



**Figure 2-16: OPEX Lockout Devices**

## 2.7.4.2. Hard-Wired Machines



### WARNING

Contact the customer's site supervisor before attempting this procedure. Only the customer's authorized site maintenance personnel are permitted to shut off the site AC power.

At some customer sites, the Sure Sort is hard-wired to a dedicated AC main disconnect switch located near the machine. To safely de-energize the Sure Sort AC Distribution enclosure, the incoming power must be shut off by turning off and locking out the customer's main disconnect switch.

An Authorized Employee or qualified electrician must proceed as follows:

1. Complete all steps under [“LOTO - Machine Maintenance and Repair” on page 33](#).
2. **Customer's site maintenance personnel only:** shut off the main AC disconnect switch and install a Lockout-Tagout device (see Figure 2-17).



**Figure 2-17: Example- AC Main Disconnect with Lockout/Tagout**

## 2.7.5. LOTO - Clearing Jams and Removing iBOTs

**This procedure should only be performed by an Authorized Employee.** It describes how to install a lockout device to the access door, in order to safely enter the aisle to clear jams and remove iBOTs.



### WARNING

Do not enter the machine while it is running, since the rapidly-moving iBOTs can pose a safety hazard.

The OPEX lockout device **MUST** be installed and locked to prevent others from inadvertently applying power while you are inside the machine.

Door interlock switches do not remove power from all electrical devices within the Sure Sort. Power to the computer and other AC devices such as power supplies remains energized after an interlock has been opened. To fully power down the machine, see [“LOTO - Machine Maintenance and Repair” on page 33](#).

1. Notify all personnel that you are about to begin the LOTO procedure.
2. If possible, park the iBOTs.
3. Place the “Caution” sign on the monitor ([Figure 2-12 on page 33](#)).
4. Lift the handle on the door, wait approx. six seconds for the safety interlock to release the door, then open the door (see Figure 2-18).



**Figure 2-18: Door Interlock Detail**

5. Insert a hasp into the hole in the door handle, then insert a padlock and warning tag into one of the holes in the hasp (see Figure 2-19).



**Figure 2-19: Hasp in Door Handle**

6. Make sure each person working on the machine installs their own lock with their name on it, or an identifying tag that cannot be easily removed or damaged. Each person must keep possession of their key.
7. Check the door to ensure that:
  - a. The interlock LED is on to indicate interlock is open (see Figure 2-20).
  - b. The door will not close.

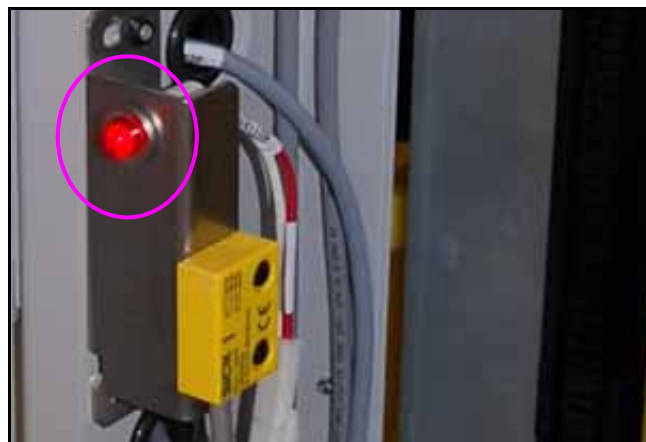

**Figure 2-20: Interlock LED**

## 2.7.6. Restoring the Machine to Normal Operation

After the jam is cleared or the required maintenance or repair is complete, the Authorized Employee shall restore the machine to normal operation as follows:

1. Remove all tools and other materials from the area.
2. Ensure the machine is closed up and operationally intact.
3. Notify operators and affected persons that the machine will be restarting.
4. Make sure everyone is safely away from the machine.
5. Verify all controls are set to the neutral or OFF position.
6. Remove all LOTO devices and “Caution” sign.
7. Restore equipment to service, and verify that the machine is safe to operate.
8. Notify operators and affected persons that LOTO devices have been removed and equipment is now ready for use.

---

---

## 2.8. Machine Labels

---

---

Labels are used in specific locations throughout the Sure Sort to alert you to certain safety hazards and provide important information about the machine. These labels may appear in various languages or styles depending on the region or country where the machine is operating:

- Bilingual English/Spanish labels for US machines
- Bilingual English/French labels for Canadian machines
- Graphics-only (no text) labels for EU, and other international machines.

Although they appear different, the locations of these labels are identical. In the following tables, a cyan-colored box will appear in the photos in the location where the label would be found (see Figure 2-21). In this example, there would be two of the *same* label in the locations shown.

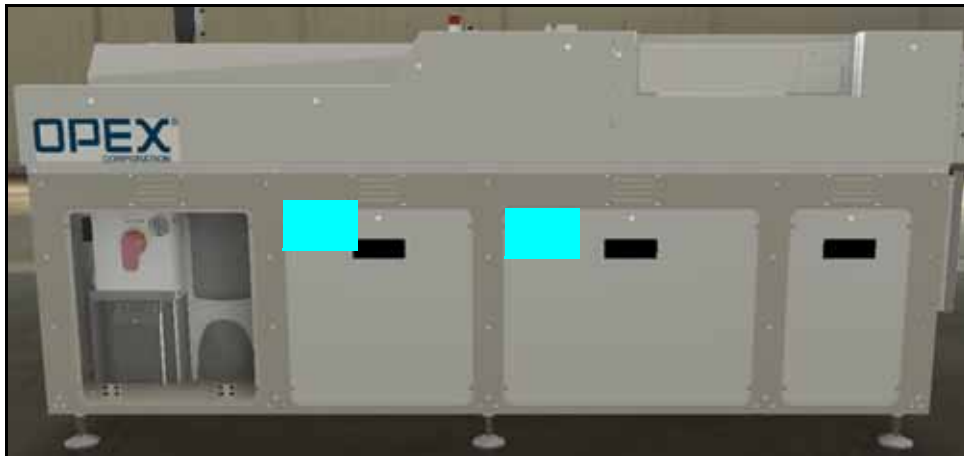

**Figure 2-21: Cyan-Colored Boxes Denote Label Location(s)**



### **WARNING**

Follow the safety precautions on all labels when operating the Sure Sort. Failure to follow these precautions may result in severe bodily injury or death as well as damage to the machine.





## 2.8.1. Input Conveyor Module Labels

### 2.8.1.1. Safe Use Notice Label

**Location:** Front of input conveyor near operator station (see Table 2-1).

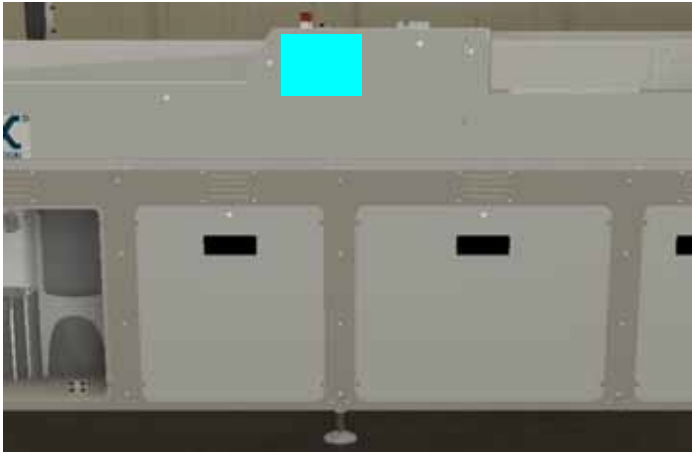
**Purpose:** Advises personnel to read Operator Manual for safe use.

**Table 2-1: Safe Use Notice Label**



Label Location	Description
	<p>US (8074300)</p> 
	<p>CA (8074310)</p> 
	<p>EU / AU / JP (8074330)</p> 

### 2.8.1.2. E-Stop Ring Label

**Location:** Front of input conveyor near operator station (see Table 2-2).

**Purpose:** Draws attention to location of Emergency Stop button.

**Table 2-2: E-Stop Ring Label**

Label Location	Description
	All Regions (8156400) 







### 2.8.1.3. Arc Flash and Shock Hazard Warning Label

**Location:** Input conveyor on front left panel where computer and UPS are accessed by operators (see Table 2-3).

**Purpose:** Advises purchaser of machine to follow all arc flash and electrical safety requirements per applicable standards.

**Table 2-3: Arc Flash and Shock Hazard Warning Label**





Label Locations	Description
<p>Left Front Panel of Input Module</p> 	<p>US (8165700)</p>  <p>CA (8165710)</p>  <p>EU / AU / JP (8165730)</p> 

## 2.8.1.4. Shock Hazard Warning Label

**Location:** Lower cover panels, next to tool-accessed latch, Qty 9 (see Table 2-4).

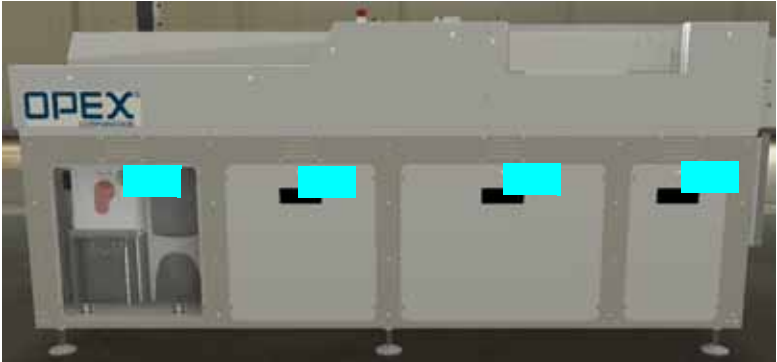
**Purpose:** Warns about electrical hazard inside, and to disconnect power before removing panel.

**Table 2-4: Shock Hazard Warning Label**

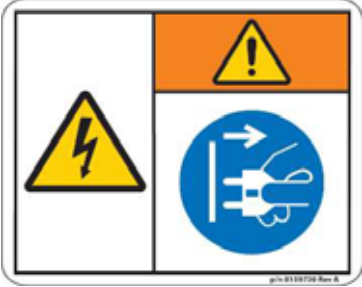
Label Locations	Description
<p>Operator Side (4x)</p>  <p>Rear Side (4x)</p>  <p>End Panel of Input Module (1x)</p> 	<p>US (8159700)</p>  <p>CA (8159710)</p>  <p>EU / AU / JP (8159730)</p> 

## 2.8.1.5. Weight Limit Label

**Location:** Rear wall of input conveyor near operator station (see Table 2-5).

**Purpose:** Warns that the machine can only process items that are less than, or equal to 5 lbs. (2.27 kg).

**Table 2-5: Weight Limit Label**

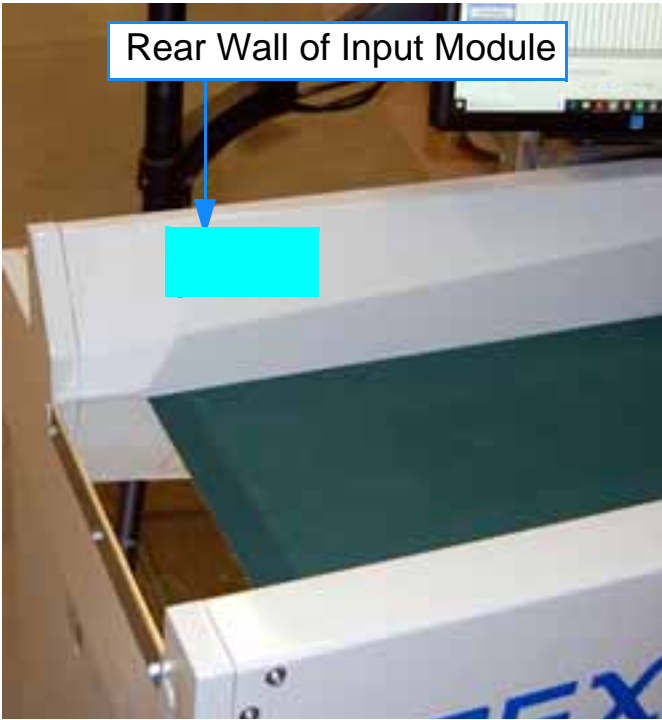
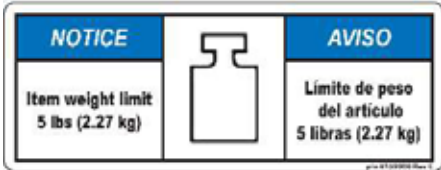
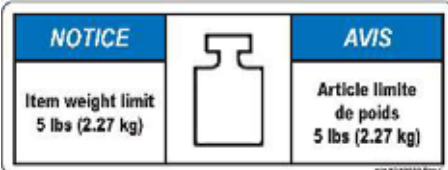
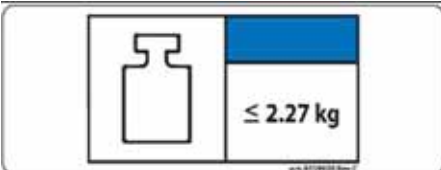
Label Location	Description
	<p>US (8159900)</p> 
	<p>CA (8159910)</p> 
	<p>EU / AU / JP (8159930)</p> 

## 2.8.1.6. Ground Symbol

**Location:** AC distribution enclosure, near rear stud (see Table 2-6).

**Purpose:** Identifies protective earth cable connection point for machines. Required due to machine leakage current.

**Table 2-6: Ground Symbol Label**

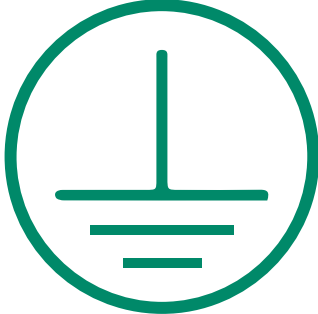
Label Locations	Description
<p data-bbox="263 590 802 625">Back of the AC Power Enclosure</p> 	<p data-bbox="1157 625 1370 730">ALL Regions (P24835-01)</p> 

### 2.8.1.7. UPS Voltage Present Warning Label

**Location:** Rear cover panel where UPS is located and operator manual holder is attached, next to tool-accessed latch (see Table 2-7).

**Purpose:** Warns about residual electrical hazard inside, and to disconnect UPS power before servicing.

**Table 2-7: UPS Voltage Present Warning Label**

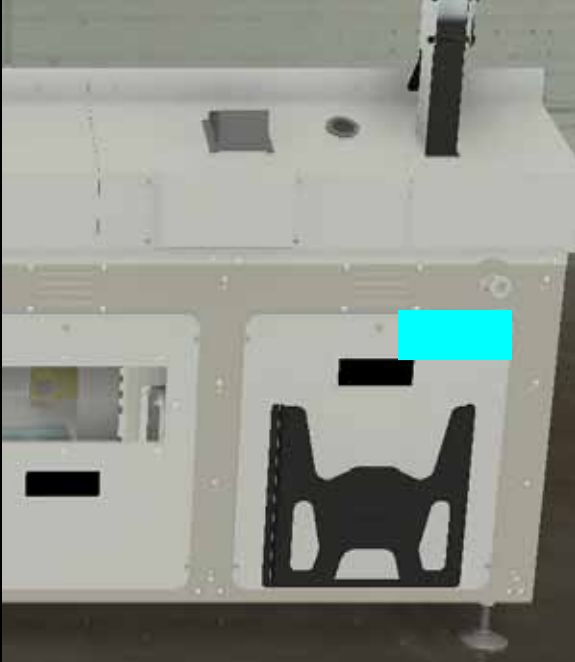
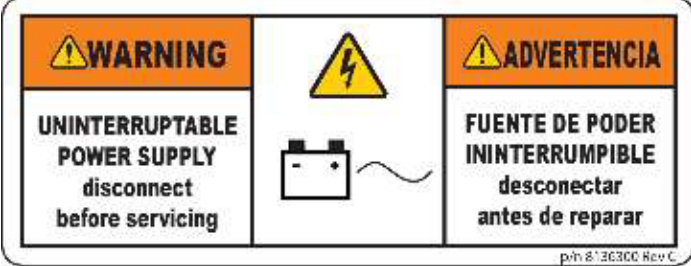
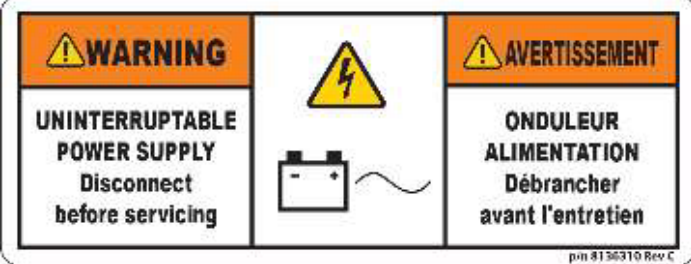
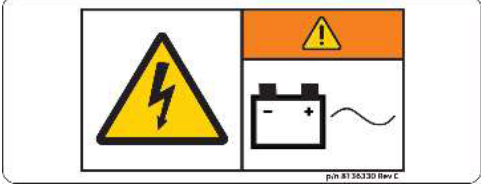



Label Locations	Description
<p>Rear of Input Module</p> 	<p>US (8136300)</p>  <p style="text-align: right; font-size: small;">pin 8136300 Rev C</p>
	<p>CA (8136310)</p>  <p style="text-align: right; font-size: small;">pin 8136310 Rev C</p>
	<p>EU / AU / JP (8136330)</p>  <p style="text-align: right; font-size: small;">pin 8136330 Rev C</p>

## 2.8.1.8. High Leakage Current Label

**Location:** AC input power cord (see Table 2-8).

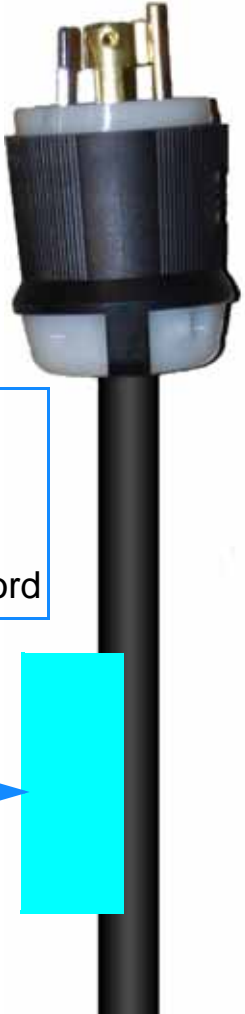
**Purpose:** Warns that Earth connection required.

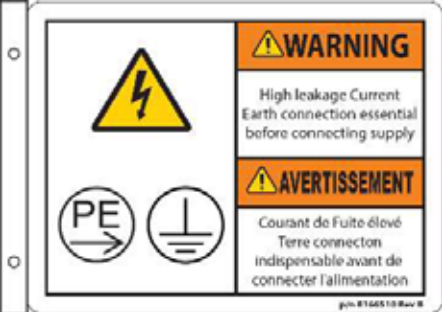
**Table 2-8: High Leakage Current Label**

Label Locations	Description
 <p data-bbox="207 997 540 1222">Attached with tie-wraps 10" to 12" before AC plug at the end of product cord</p>	<p>US (8166500)</p>
	
	<p>CA (8166510)</p>
	
<p>EU / AU / EU (8166530)</p>	
	

## 2.8.1.9. Machine Supply Circuit Disconnect Label

**Location:** AC input power cord (see Table 2-8).

**Purpose:** Informs that disconnecting will remove power to machine.

**Table 2-9: Machine Supply Circuit Disconnect Label**

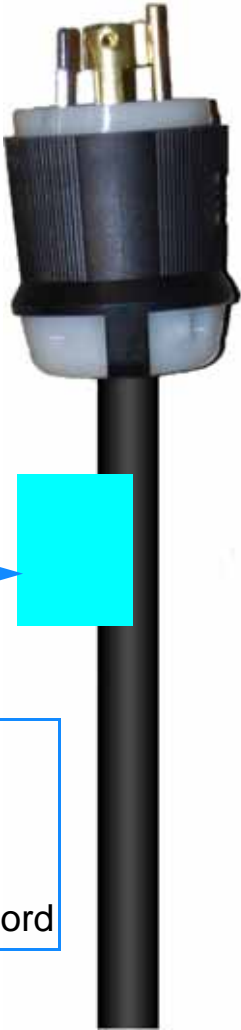
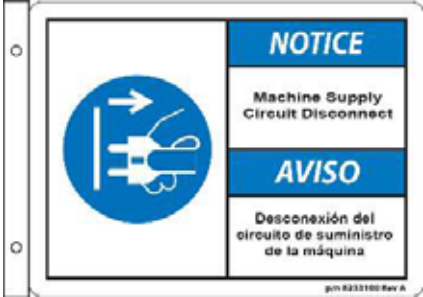
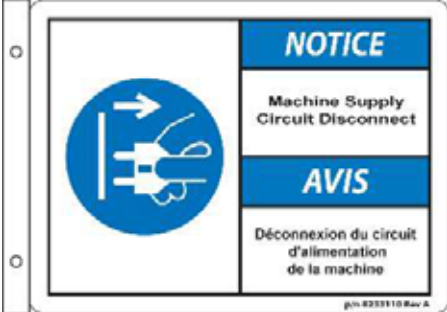
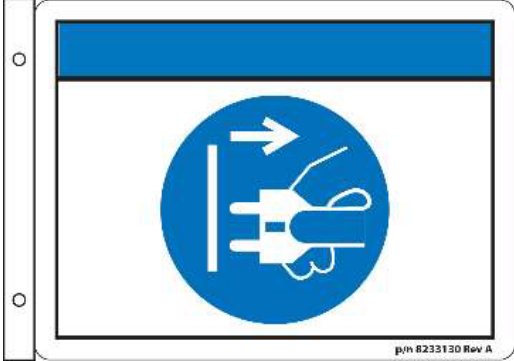
Label Locations	Description
 <p data-bbox="219 1333 553 1562">Attached with tie-wraps 5" to 6" before AC plug at the end of product cord</p>	<p>US (8233100)</p>
	
	<p>CA (8233110)</p>
	
<p>EU / AU / EU (8233130)</p>	
	











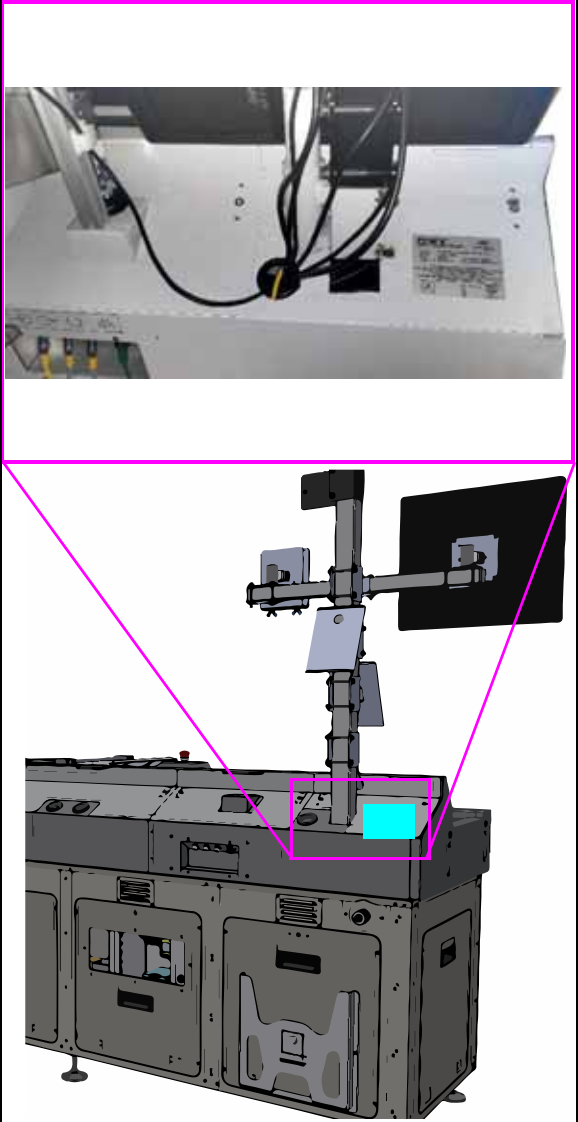



## 2.8.1.10. Ratings/ Serial Number Label

**Location:** Rear wall of conveyor near monitor arm (see Table 2-10).

**Purpose:** Identifies product electrical ratings, machine serial number, D.O.M., NRTL logo for U.S. & Canada, CE for EU & AU, patents, and 50/60 Hz for JP.

**Table 2-10: Ratings/Serial Number Label**

Label Locations	Description
	<p style="text-align: center;"><b>US / Canada (8237900)</b></p> <div style="border: 1px dashed black; padding: 5px;">   <p>305 COMMERCE DRIVE MOORESTOWN, NJ 08057 USA</p> <p>Voltage 208/120 VAC, 1PH, 60Hz (2W + N + PE)            Current 12 A Full Load            SCCR 200 kA Document # 5092000            Largest Load 208VAC 5A Max amb temp 90°F (32.2°C)</p> <p>Subject to one or more of the following patents:            U.S.: 7,861,844 8,104,601 8,622,194 8,726,7409,010,517 10,052,661 10,071,857            CANADA: 2673932 JAPAN: JP5562646 KOREA: KR101489337            EUROPE: EP2121204 Other patents pending.            FIRMWARE AND SOFTWARE COPYRIGHT 2007 - 2020 ALL RIGHTS RESERVED            OPEX CORPORATION MOORESTOWN, NJ USA</p>   SERIAL NO. _____            D.O.M. _____  <small>sh 8237900 Rev. A</small> </div> <p style="text-align: center;"><b>EU / AU (8237930)</b></p> <div style="border: 1px dashed black; padding: 5px;">   <p>305 COMMERCE DRIVE MOORESTOWN, NJ 08057 USA</p> <p>Voltage 230 VAC, 1PH, 50Hz (1W + N + PE)            Current 12 A Full Load            SCCR 200 kA Document # 5092000            Largest Load 230VAC 5A Max amb temp 90°F (32.2°C)</p> <p>Subject to one or more of the following patents:            U.S.: 7,861,844 8,104,601 8,622,194 8,726,7409,010,517 10,052,661 10,071,857            CANADA: 2673932 JAPAN: JP5562646 KOREA: KR101489337            EUROPE: EP2121204 Other patents pending.            FIRMWARE AND SOFTWARE COPYRIGHT 2007 - 2020 ALL RIGHTS RESERVED            OPEX CORPORATION MOORESTOWN, NJ USA</p>   SERIAL NO. _____            D.O.M. _____  <small>sh 8237930 Rev. B</small> </div> <p style="text-align: center;"><b>JP (8237940)</b></p> <div style="border: 1px dashed black; padding: 5px;">   <p>305 COMMERCE DRIVE MOORESTOWN, NJ 08057 USA</p> <p>Voltage 200 VAC, 1PH, 50/60Hz (2W + PE)            Current 12 A Full Load            SCCR 200 kA Document # 5092000            Largest Load 200VAC 5A Max amb temp 90°F (32.2°C)</p> <p>Subject to one or more of the following patents:            U.S.: 7,861,844 8,104,601 8,622,194 8,726,7409,010,517 10,052,661 10,071,857            CANADA: 2673932 JAPAN: JP5562646 KOREA: KR101489337            EUROPE: EP2121204 Other patents pending.            FIRMWARE AND SOFTWARE COPYRIGHT 2007 - 2020 ALL RIGHTS RESERVED            OPEX CORPORATION MOORESTOWN, NJ USA</p>   SERIAL NO. _____            D.O.M. _____  <small>sh 8237940 Rev. B</small> </div>







## 2.8.1.11. Shock Hazard Warning Label

**Location:** Front of Safety enclosure; Front of I/O enclosure (see Table 2-11).

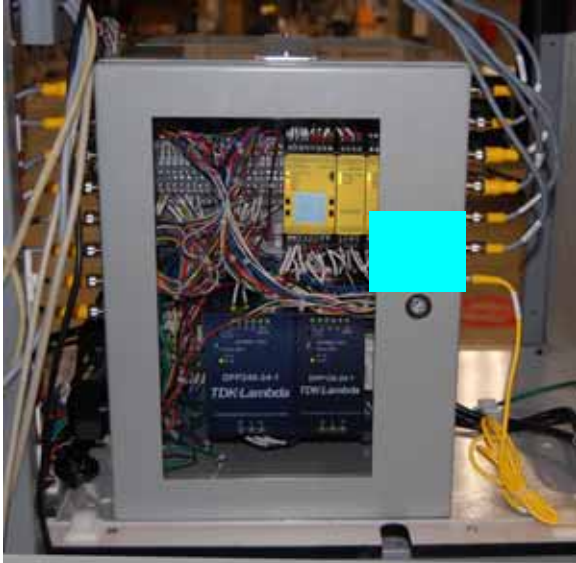
**Purpose:** Warns about electrical hazard inside, and to disconnect power before opening enclosure.

**Table 2-11: Shock Hazard Warning Label**

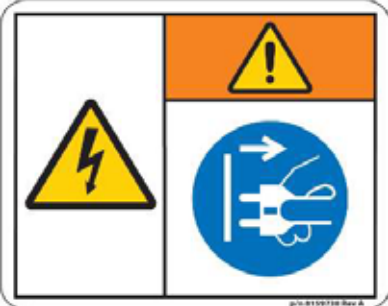
Label Locations	Description
<p data-bbox="337 552 758 590">Front of Safety Enclosure</p> 	<p data-bbox="1073 611 1308 648">US (8159700)</p> 
<p data-bbox="363 1213 732 1251">Front of I/O Enclosure</p> 	<p data-bbox="1073 1010 1308 1050">CA (8159710)</p>  <p data-bbox="997 1415 1386 1455">EU / AU / JP (8159730)</p> 





## 2.8.1.12. Shock Hazard Warning Label

### DC Power Supplies (Charge 28V, Clear Path Motors 75V)

**Location:** Inside the input module cabinet, front & back (see Table 2-12).

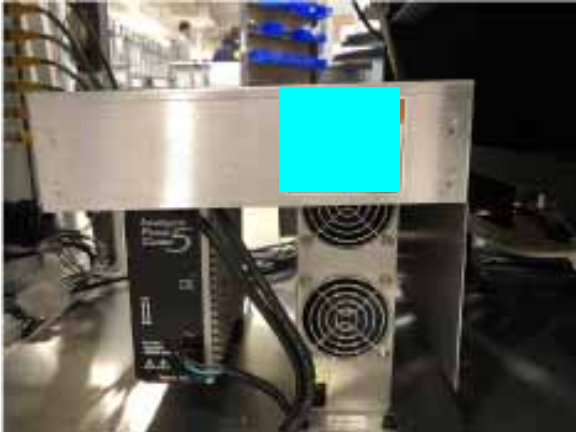
**Purpose:** Warns about electrical hazard inside, and to disconnect power before opening enclosure.

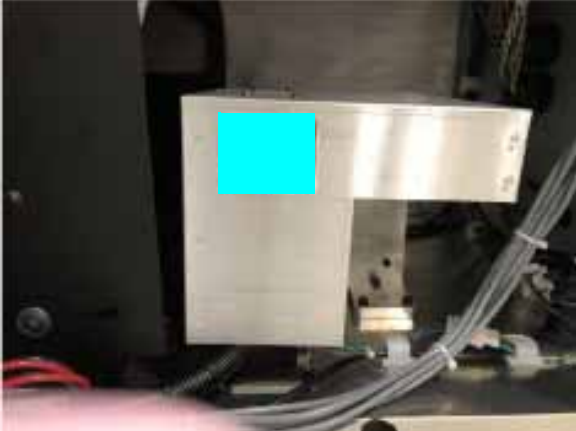
**Table 2-12: Shock Hazard Warning Label**

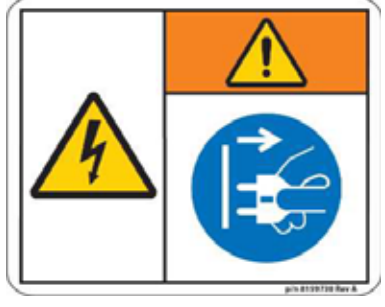
Label Locations	Description
<p>DC Power Supplies (28V, 75V) cover Front</p> 	<p>US (8159700)</p> 
<p>Back</p>	
	<p>CA (8159710)</p>  <p>EU / AU / JP (8159730)</p> 

### 2.8.1.13. External I/O Interface Panel Label

**Location:** Top-rear-center of the Input Conveyor module (see Table 2-13).

**Purpose:** Identifies each of the four cable connections.

**Table 2-13: External IO 4-Connectors Panel Label**

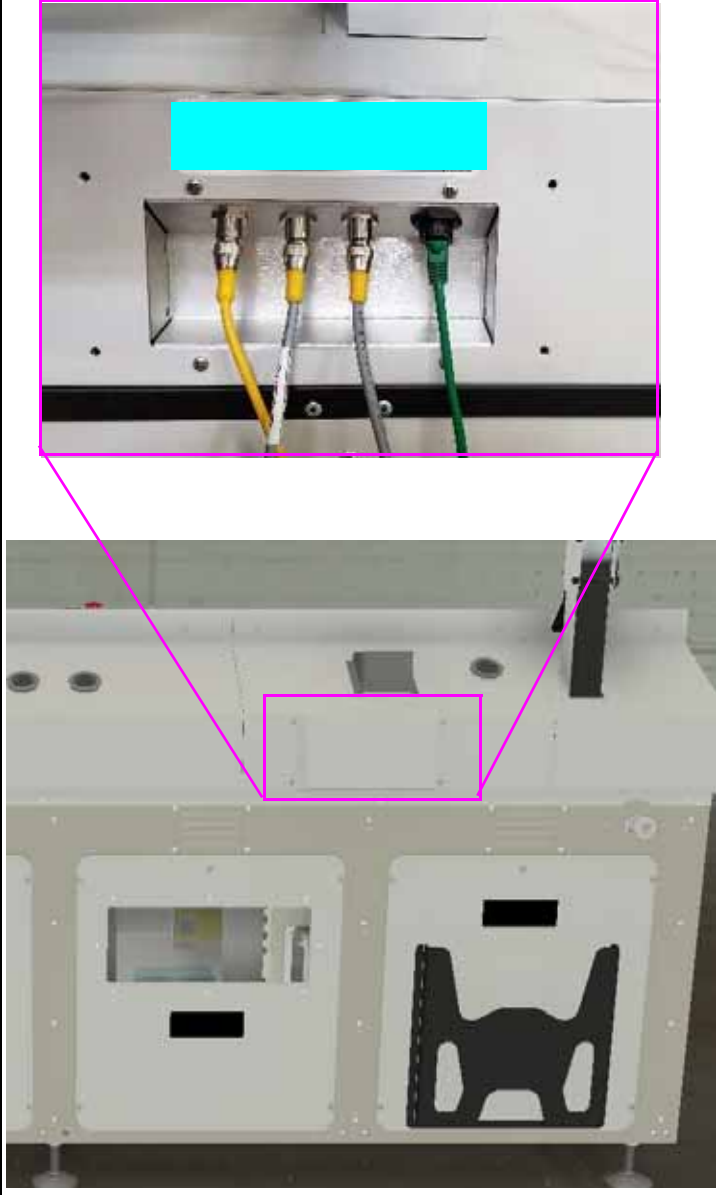
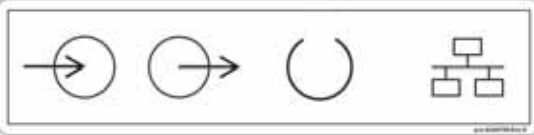

Label Location	Description
	<p data-bbox="1079 951 1302 993">All (8244700)</p> 

## 2.8.1.14. Supplementary Machine Supply Circuit Switch

**Location:** ON/OFF switch assembly on front left panel of the Input Conveyor (see Table 2-14).

**Purpose:** Indicates the switch is a supplementary power switch in the machine supply circuit.

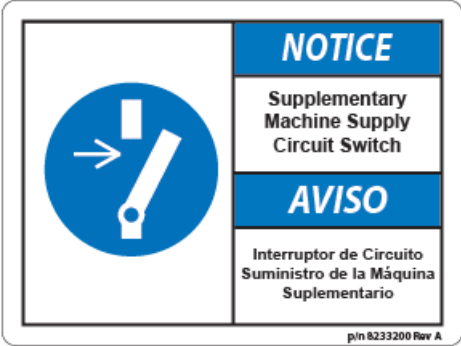
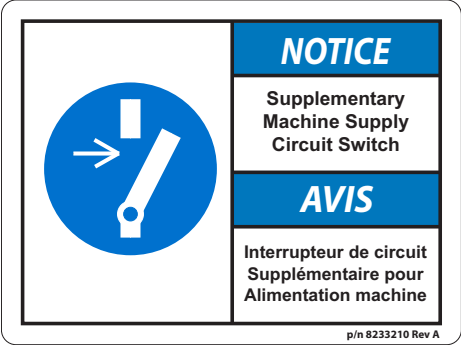
**Table 2-14: Supplementary Machine Supply Circuit Switch Label**



Label Location	Description
	<p>US (8233200)</p> 
	<p>CA (8233210)</p> 
	<p>AU, EU, JP (8233230)</p> 

## 2.8.1.15. Shock Hazard Warning Label

**Location:** ON/OFF switch assembly upper left corner (Table 2-15).

**Purpose:** Warns about electrical hazard inside, and to disconnect power before removing panel.

**Table 2-15: Shock Hazard Warning Label**

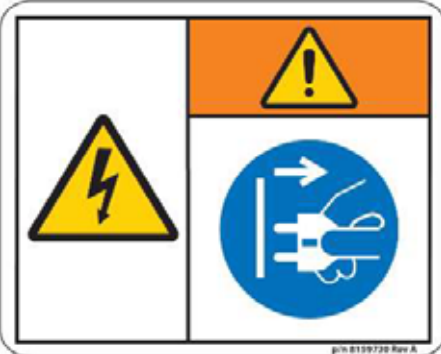
Label Location	Description
	<p>US (8159700)</p> 
	<p>CA (8159710)</p> 
	<p>EU / AU / JP (8159730)</p> 





## 2.8.2. Return Conveyor Module Labels

### 2.8.2.1. Shock Hazard Warning Label

**Location:** Access panel, underside of return conveyor, next to tool-accessed panel latch (see Table 2-16).

**Purpose:** Warns about electrical hazard inside, and to disconnect power before opening panel.

**Table 2-16: Shock Hazard Warning Label**

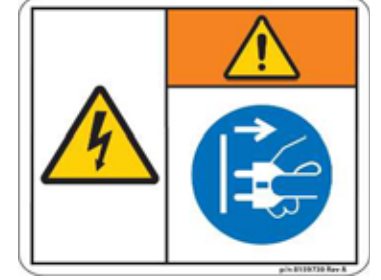

Label Locations	Description
	<p>US (8159700)</p> 
	<p>CA (8159710)</p> 
	<p>EU / AU / JP (8159730)</p> 

## 2.8.2.2. Pinch Point Caution Label

**Location:** Return conveyor, all front and side surfaces (see Table 2-17).

**Purpose:** Warns about pinch hazards at gaps near conveyor belt.

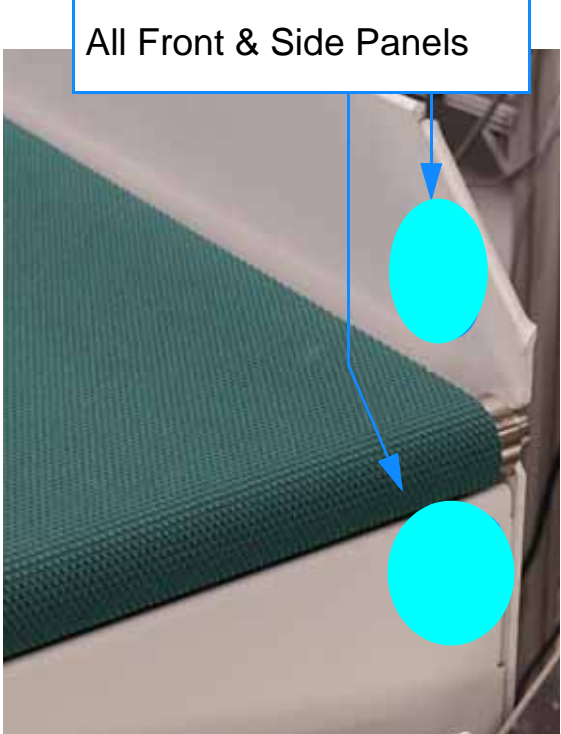
**Table 2-17: Pinch Point Caution Label**

Label Locations	Description
 <p>All Front &amp; Side Panels</p>	<p>All Regions (1637200)</p> 

### 2.8.2.3. Height Adjustment Label

**Location:** On top of each support leg of the return conveyor, and positioned 1” above handle coupling, two places (see Table 2-18).

**Purpose:** Provides directions for raising/lowering return conveyor.

**Table 2-18: Return Conveyor Height Adjustment Label**

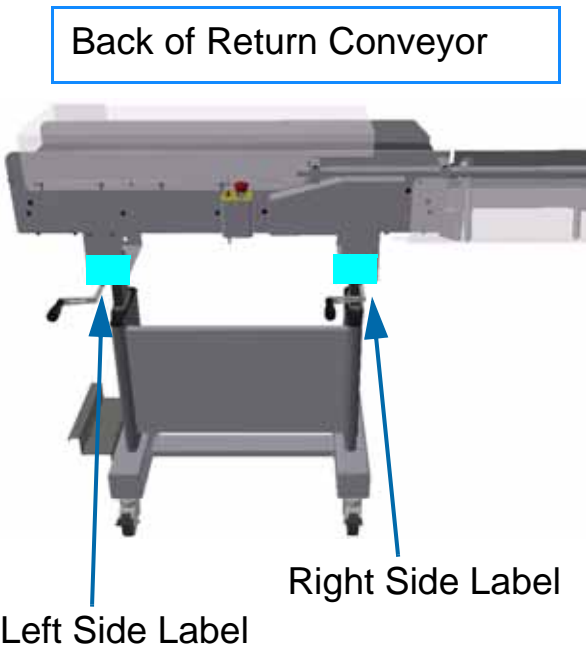
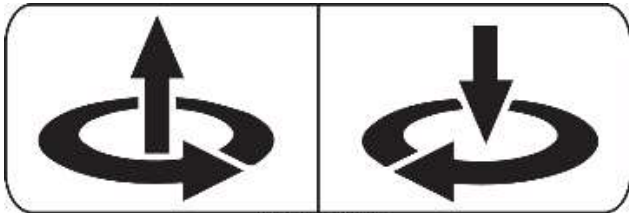
Label locations	Description
 <p>Back of Return Conveyor</p> <p>Left Side Label</p> <p>Right Side Label</p>	<p>All Regions (8175400)</p>  <p>p/n 8175400 Rev B</p>



## 2.8.2.4. Serial Number Label

**Location:** Return conveyor rear (see Table 2-19).

**Purpose:** Associates module with machine.

**Table 2-19: Serial Number Label**

Label Locations	Description
	<p>All Regions (8174000)</p> 



## 2.8.3. Scan Tunnel Labels

### 2.8.3.1. Shock Hazard Warning Label

**Location:** Scan Tunnel, front of electrical relay housing (see Table 2-20).

**Purpose:** Warns about electrical hazard inside, and to disconnect power before opening enclosure.

**Table 2-20: Shock Hazard Warning Label**

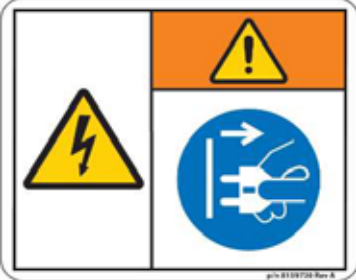
Label Locations	Description
	<p>US (8159700)</p> 
	<p>CA (8159710)</p> 
	<p>EU / AU / JP (8159730)</p> 

### 2.8.3.2. Serial Number Label

**Location:** Scan Tunnel, front of electrical relay housing (see Table 2-21).

**Purpose:** Associates module with machine.

**Table 2-21: Serial Number Label**





Label Locations	Description
	<p>All Regions (8174000)</p> 

### 2.8.3.3. Arc Flash and Shock Hazard Warning Label

**Location:** Scan Tunnel, three places (see Table 2-22).

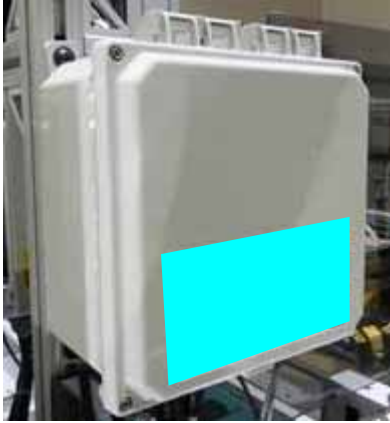
**Purpose:** Advises purchaser of machine to follow all arc flash and electrical safety requirements per applicable standards.

**Table 2-22: Arc Flash and Shock Hazard Warning Label**

Label Locations	Description
<p data-bbox="337 682 711 720">Scan Tunnel IO Boxes</p>  <p data-bbox="305 1024 769 1062">Scan Tunnel Relay Housing</p> 	<p data-bbox="1052 527 1284 564">US (8165700)</p> <div data-bbox="889 583 1458 865">  </div> <p data-bbox="1052 919 1284 957">CA (8165710)</p> <div data-bbox="889 982 1458 1264">  </div> <p data-bbox="976 1304 1360 1341">EU / AU / JP (8165730)</p> <div data-bbox="889 1352 1458 1633">  </div>



## 2.8.4. Base and End Module Labels

### 2.8.4.1. Serial Number Label

**Location:** Inside front door, above interlock lamp (see Table 2-23).

**Purpose:** Indicates base machine serial number.

**Table 2-23: Serial Number Label**



Label Locations	Description
	<p>All Regions (8174000)</p> 

## 2.8.4.2. Shock Hazard Warning Label

**Location:** Electrical enclosure access cover, floor of base module (see Table 2-24).

**Purpose:** Warns about electrical hazard inside, and to disconnect power before opening enclosure.

**Table 2-24: Shock Hazard Warning Label**

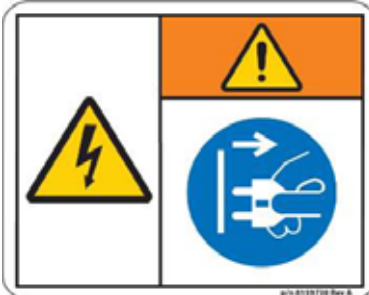
Label Locations	Description
	<p>US (8159700)</p> 
	<p>CA (8159710)</p> 
	<p>EU / AU / JP (8159730)</p> 







### 2.8.4.3. Falling Hazard Caution Label

**Location:** Exterior of base module, two places (see Table 2-25).

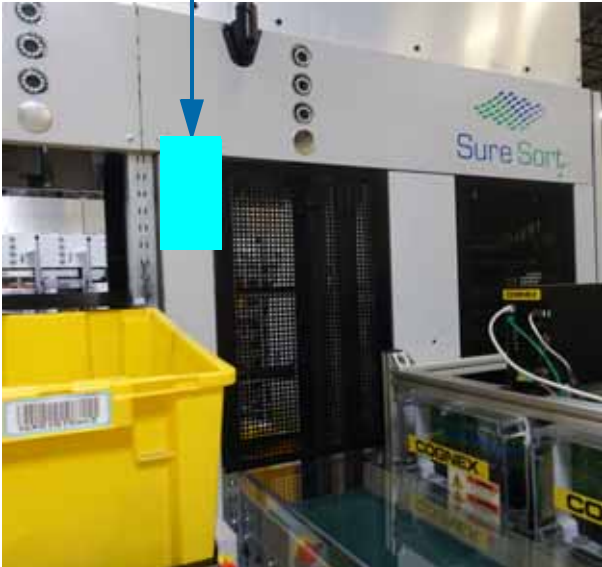
**Purpose:** Cautions not to climb structure due to falling hazard.

**Table 2-25: Falling Hazard Caution Label**





Label Locations	Description
<p>Above the Return Conveyor</p> 	<p>US (7686200)</p> 
<p>Right Side of the First Delivery Column</p> 	<p>CA (7686210)</p> 
	<p>EU / AU / JP (7686230)</p> 

## 2.8.4.4. Crush Hazard Caution Label

**Location:** Top panel, 200 side (right) of base module (see Table 2-26).

**Purpose:** Caution to keep hands away from interior of machine due to crush hazard from moving parts.

**Table 2-26: Crush Hazard Caution Label**

Label Locations	Description
<p>Centered above Left Track upright.</p> 	<p>US (8187900)</p> 
	<p>CA (8187910)</p> 
	<p>EU / AU / JP (8187930)</p> 







## 2.8.4.5. Reset Button Label

**Location:** Reset button housing, next to front and rear door (see Table 2-27).

**Purpose:** Identifies Reset button.

**Table 2-27: Reset Button Label**

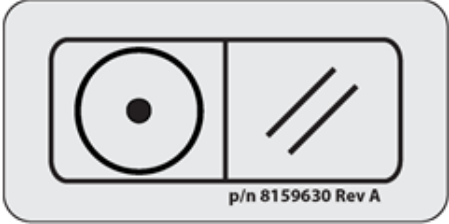

Label Locations	Description
<p data-bbox="289 520 623 558">Front Door Location</p> 	<p data-bbox="980 575 1211 613">US (8159600)</p> 
<p data-bbox="282 1150 607 1188">Rear Door Location</p> 	<p data-bbox="980 974 1211 1012">CA (8159610)</p>  <p data-bbox="902 1394 1292 1432">EU / AU / JP (8159630)</p> 

### 2.8.4.6. E-Stop Ring Label

**Location:** Right side of reject bin enclosure; column behind return conveyor (see Table 2-28).

**Purpose:** Draws attention to location of Emergency Stop button.

**Table 2-28: E-Stop Ring Label**





Label Location	Description
	<p data-bbox="1008 877 1377 919">All Regions (8156400)</p> 

## 2.8.4.7. "PUSH TO OPEN" Label

**Location:** On the inside door release of both the front base module door, and rear expansion module door (see Table 2-29).

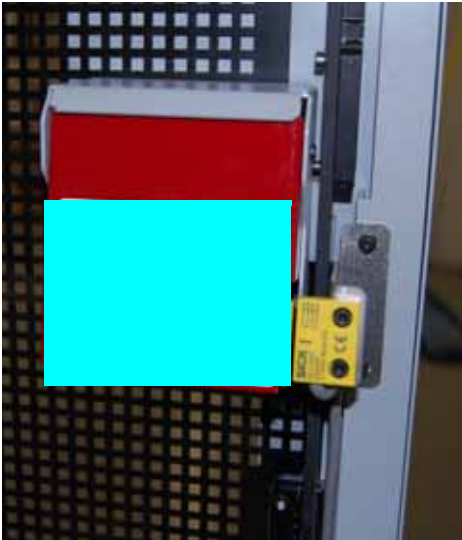
**Purpose:** Instructs how to open the door to exit the machine.

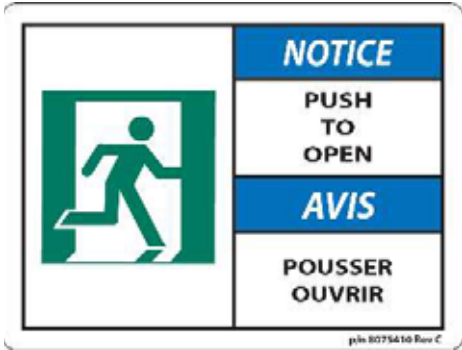
**Table 2-29: "PUSH TO OPEN" Label**

Label Locations	Description
<p data-bbox="230 695 667 768">Inside Door Release, Front &amp; Rear Access Door</p> 	<p data-bbox="1003 527 1235 562">US (8075400)</p> 
	<p data-bbox="1003 997 1235 1033">CA (8075410)</p> 
	<p data-bbox="927 1470 1312 1505">EU / AU / JP (8075430)</p> 

## 2.8.4.8. Access Forbidden Warning Label

**Location:** Exterior of front and rear access door (see Table 2-30).

**Purpose:** Warning that entry into the machine is not permitted, except by authorized personnel.

**Table 2-30: Access Forbidden Warning Label**

Label Locations	Description
<p>Front and Rear Access Door</p> 	<p>US (8074400)</p> 
	<p>CA (8074410)</p> 
	<p>EU / AU / JP (8074430)</p> 

## 2.8.4.9. Delayed Access Label

**Location:** Exterior of front and rear access door (see Table 2-31).

**Purpose:** Instructs authorized personnel how to open the door.

**Table 2-31: Delayed Access Label**

Label Locations	Description
<p style="text-align: center;">Front and Rear Access Door</p> 	<p style="text-align: center;">US (8164100)</p> 
	<p style="text-align: center;">CA (8164110)</p> 
	<p style="text-align: center;">EU / AU / JP (8164130)</p> 

## 2.8.4.10. Confined Space Notice Label

**Location:** Exterior of front and rear access door (see Figure 2-22).

**Purpose:** Notifies personnel of confined interior space of machine.

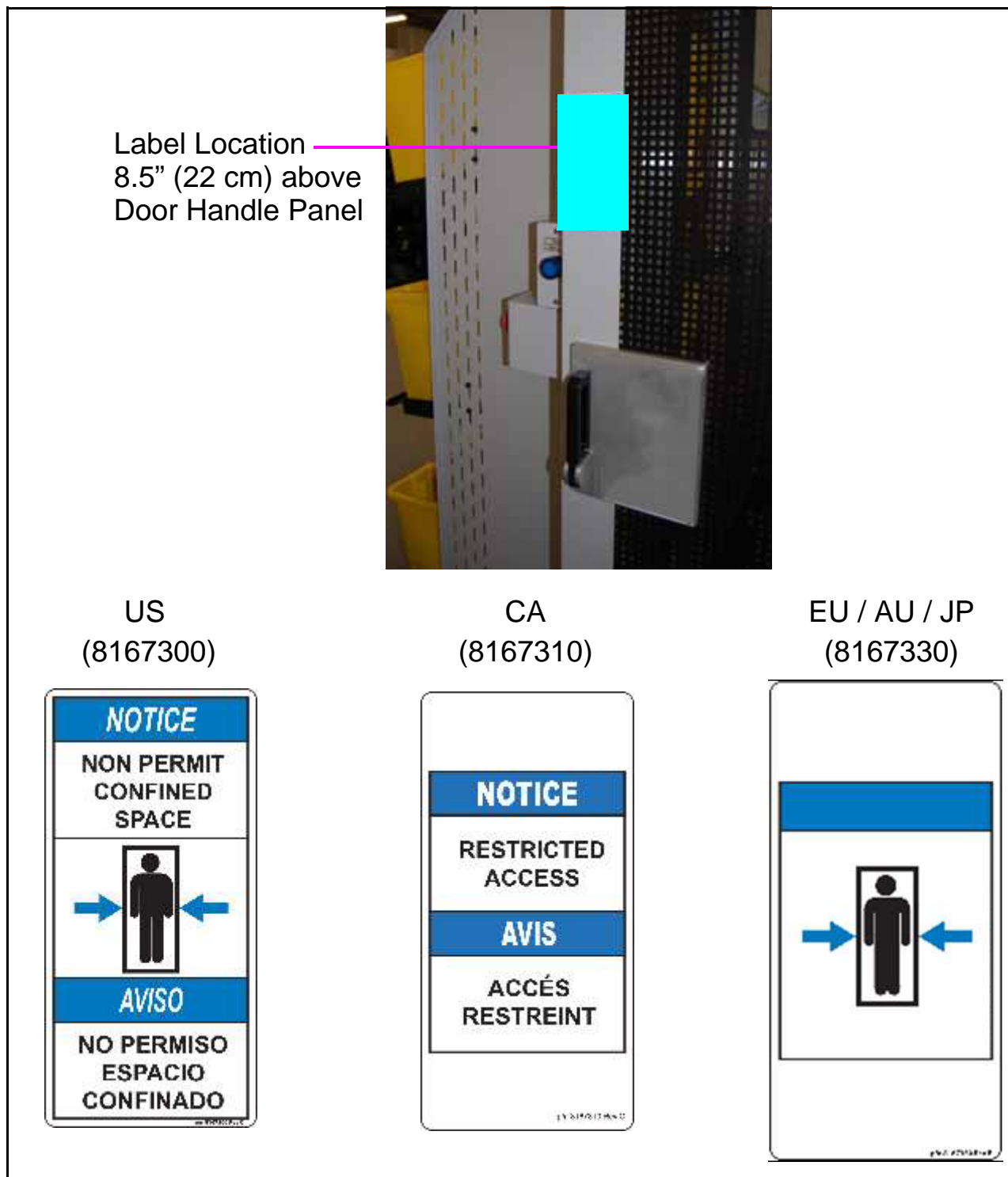

**Figure 2-22: Confined Space Notice Label**





## 2.8.4.11. Radio Compliance Label

**Location:** Main transceiver enclosure, front and rear (see Table 2-32).

**Purpose:** Acknowledges compliance with FCC & I.C. (or other governing body) rules and regulations for radio equipment.

**Table 2-32: Radio Compliance Label**

Label Locations	Description
 <p data-bbox="261 579 722 674">REAR: Right side of Main Transceiver Enclosure</p>	<p data-bbox="964 688 1276 730">US / CA (7682610)</p> <div data-bbox="797 783 1446 942" style="border: 1px solid black; padding: 5px;">  <p data-bbox="938 793 1446 905">This device complies with Part 15 of the FCC rules. Operation is subject to the following two conditions: (1) this device may not cause harmful interference, and (2) this device must accept any interference received, including interference that may cause undesired operation.</p> <p data-bbox="805 915 1393 930">Contains FCC ID: VDM2054710 Contains IC: 7175A-2054710 Model: 205471010 OPEX® Corporation</p> </div> <p data-bbox="1003 999 1235 1041">EU / AU (N/A)</p>
 <p data-bbox="215 1199 667 1293">FRONT: Center of Main Transceiver Enclosure</p>	<p data-bbox="834 1142 1403 1226">Refer to the <b>CE-Mark</b> on the machine's Electrical Ratings Label</p> <p data-bbox="821 1331 1422 1373">JP only: MIC Registration (7682640)</p> <div data-bbox="883 1415 1360 1570" style="text-align: center;">  <p data-bbox="1000 1446 1360 1503"><b>R 012-170046</b></p> <p data-bbox="954 1524 1284 1570"><b>Model: 2054710</b></p> </div> <p data-bbox="1446 1419 1468 1581" style="writing-mode: vertical-rl; transform: rotate(180deg);">p/n 7682640 Rev C</p>





## 2.8.5. Expansion and End Module Labels

### 2.8.5.1. Falling Hazard Caution Label

**Location:** Exterior of last expansion module (see Table 2-33).

**Purpose:** Cautions not to climb structure due to falling hazard.

**Table 2-33: Falling Hazard Caution Label**

Label Locations	Description
<p>Expansion End Module, Right Side</p> 	<p>US (7686200)</p> 
<p>Expansion End Module, Left Side</p> 	<p>CA (7686210)</p> 
	<p>EU / AU / JP (7686230)</p> 





## 2.8.5.2. Shock Hazard Warning Label

**Location:** Electrical enclosure access cover, floor of expansion modules (see Table 2-34).

**Purpose:** Warns about electrical hazard inside, and to disconnect power before opening enclosure.

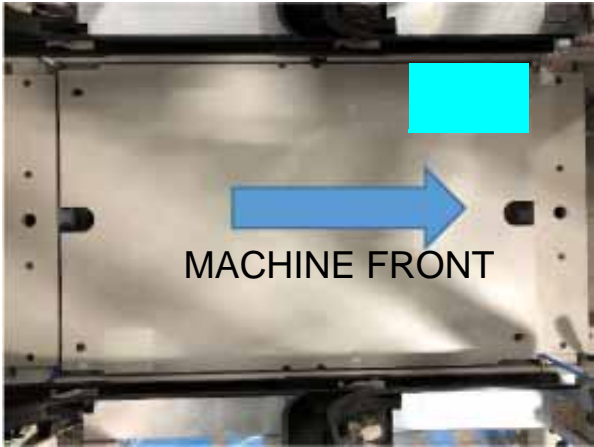
**Table 2-34: Shock Hazard Warning Label**

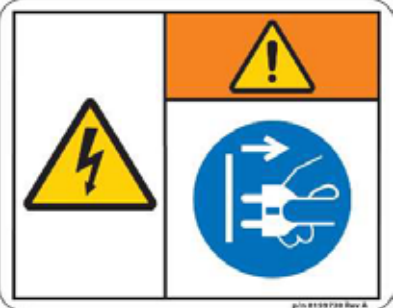
Label Locations	Description
	<p>US (8159700)</p> 
	<p>CA (8159710)</p> 
	<p>EU / AU / JP (8159730)</p> 

### 2.8.5.3. Crush Hazard Caution Label

**Location:** Top panel, left and right side of expansion module (see Table 2-35).

**Purpose:** Caution to keep hands away from interior of machine due to crush hazard from moving parts.

**Table 2-35: Crush Hazard Caution Label**



Label Locations	Description
<p>Expansion Module, Left Side</p> 	<p>US (8187900)</p> 
<p>Expansion Module, Right Side</p> 	<p>CA (8187910)</p> 
	<p>EU / AU / JP (8187930)</p> 

## 2.8.5.4. E-Stop Ring Label

**Location:** Last expansion module, left and right side (see Table 2-36). For 11-expansion machines, this label will also be located mid aisle: on the 100 side, E-stop is at column R; on the 200 side, at column Q (per ECO 19-1755).

**Purpose:** Draws attention to location of Emergency Stop button.

**Table 2-36: E-Stop Ring Label**





Label Location	Description
<p data-bbox="267 619 820 661">End Expansion Module, Left Side</p>  <p data-bbox="259 1155 836 1197">End Expansion Module, Right Side</p> 	<p data-bbox="1006 808 1380 850">All Regions (8156400)</p> 

## 2.8.5.5. “Do Not Step” Caution Label

**Location:** Centered on the two lowest bin brackets (see Table 2-37).

**Purpose:** Cautions not to climb structure due to falling hazard.

**Table 2-37: “Do Not Step” Caution Label**



Label Location	Description
	<p style="text-align: center;">US (8204700)</p>  <p style="text-align: right; font-size: small;">p/n 8204700 Rev A</p>
	<p style="text-align: center;">CA (8204710)</p>  <p style="text-align: right; font-size: small;">p/n 8204710 Rev A</p>
	<p style="text-align: center;">EU / AU / JP (8204730)</p>  <p style="text-align: right; font-size: small;">p/n 8204730 Rev A</p>

## 2.8.5.6. Bracket Visibility Label

**Location:** Front of custom bin brackets (see Table 2-38).

**Purpose:** Visibility of front of bracket.

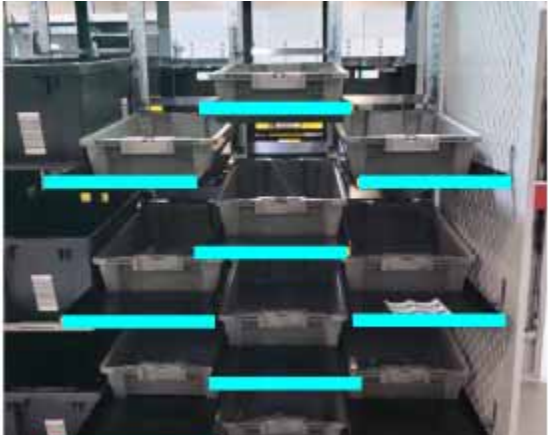
**Table 2-38: Bracket Visibility Label**

Label Location	Description
	<p data-bbox="922 594 1317 636">ALL Regions (8206000)</p> 



## 2.8.5.7. Serial Number Label

### Expansion Module

**Location:** Bottom frame structure, each expansion module (see Table 2-39).

**Purpose:** Associates module with machine.

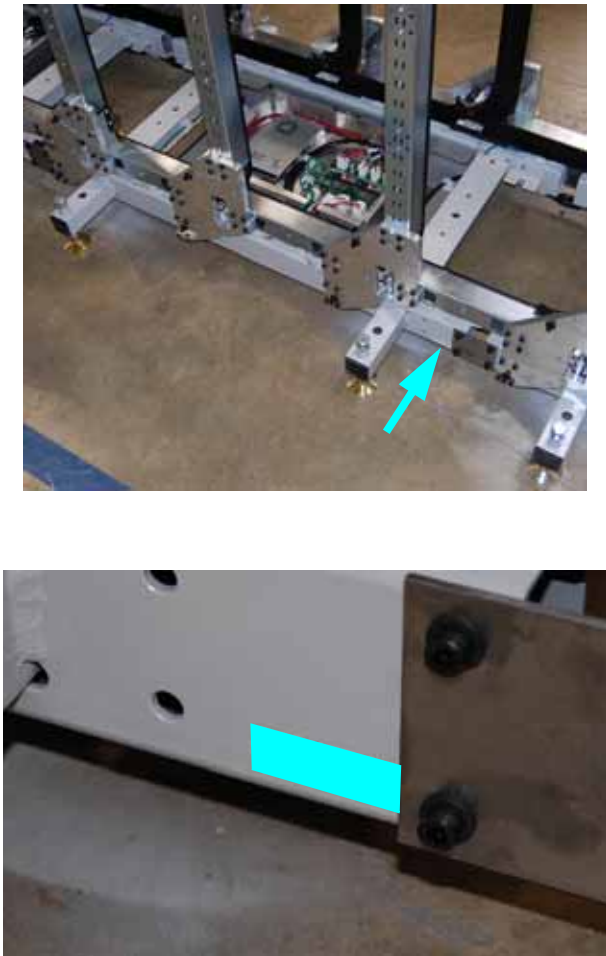
**Table 2-39: Serial Number Label**

Label Locations	Description
	<p>All Regions (8174000)</p> 

## 2.8.5.8. Serial Number Label

### End Module

**Location:** Inside back door, above interlock lamp (see Table 2-40).

**Purpose:** Associates module with machine.

**Table 2-40: Serial Number Label**

Label Locations	Description
	<p>All Regions (8174000)</p> 



## 2.8.6. iBOT Labels

### 2.8.6.1. iBOT Serial Number Label

**Location:** iBOT chassis, two places (see Table 2-41).

**Purpose:** Identifies iBOT associated with machine.

**Table 2-41: iBOT Serial Number Label**

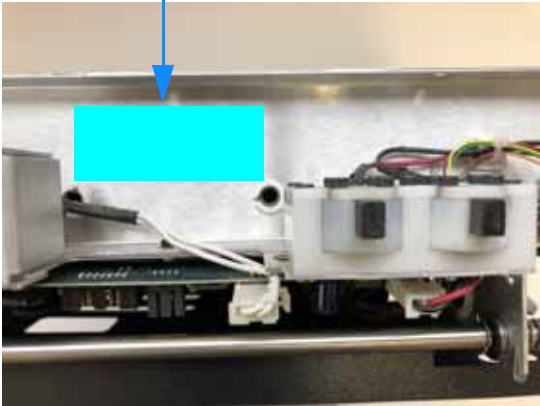
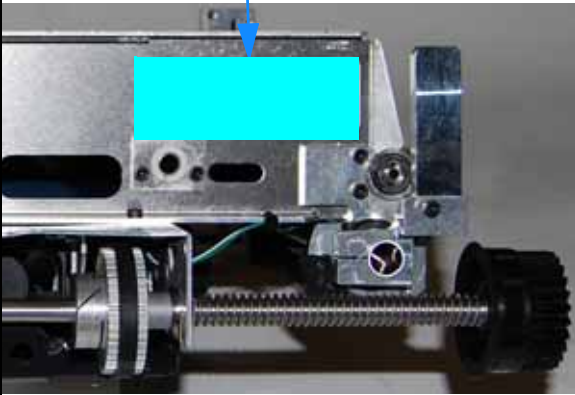
Label Locations	Description
<p data-bbox="212 642 578 705">Center front of iBOT</p>  <p data-bbox="256 1161 670 1241">Right side of chassis, as viewed from rear of iBOT</p> 	<p data-bbox="938 1035 1305 1073">All Regions (7242808)</p> <div data-bbox="805 1131 1435 1360" style="border: 1px solid black; padding: 5px; background-color: #f0f0f0;"> <p data-bbox="816 1157 1357 1220"><b>SERIAL # SBXXXXXX</b></p> <p data-bbox="816 1234 1414 1276"><b>SURE SORT® IBOT® PART#9161308</b></p> <p data-bbox="1003 1293 1203 1314"><b>ALL RIGHTS RESERVED</b></p> <p data-bbox="821 1325 1008 1346"><b>OPEX CORPORATION</b></p> <p data-bbox="1089 1325 1252 1346"><b>MOORESTOWN, NJ</b></p> <p data-bbox="1300 1325 1382 1346"><b>MM/YYYY</b></p> </div>



## 2.8.6.2. iBOT Control Panel Label

**Location:** iBOT control panel, front of iBOT (see Table 2-42).

**Purpose:** Identifies indicator lights and switches.

**Table 2-42: iBOT Control Panel Label**

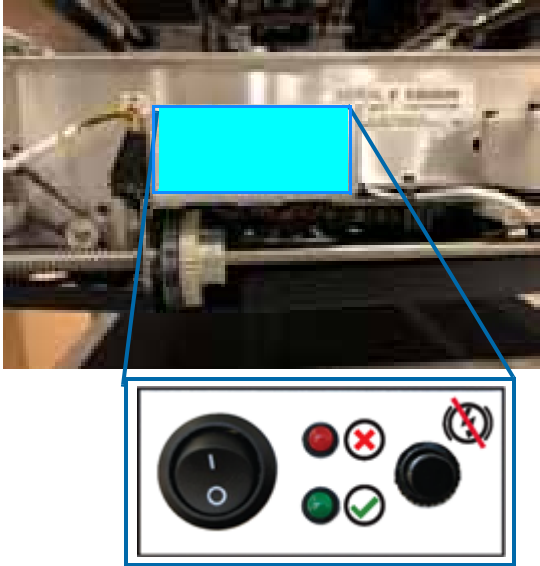
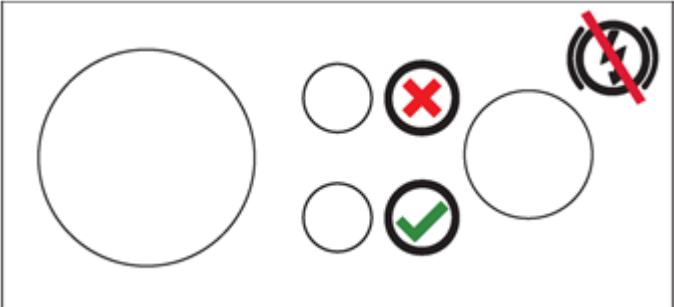
Label Locations	Description
	<p>All Regions (7242710)</p> 

## 2.8.6.3. iBOT Stored Energy Caution Label

**Location:** iBOT bottom safety cover (see Table 2-43).

**Purpose:** Cautions personnel about stored electrical charge inside.

**Table 2-43: iBOT Stored Energy Caution Label**

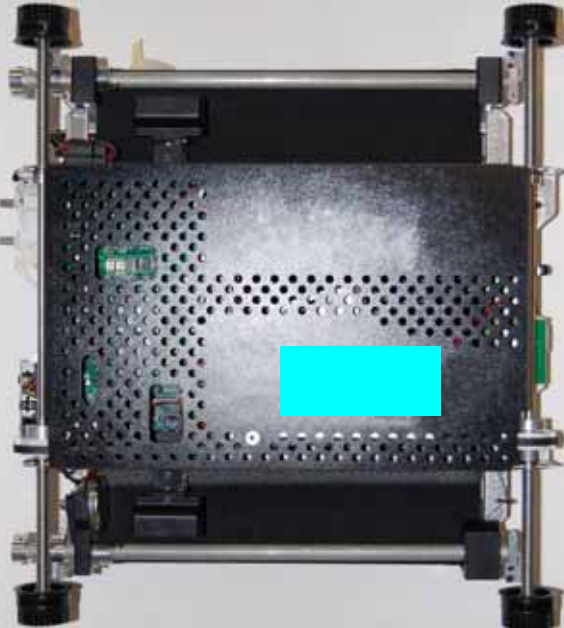
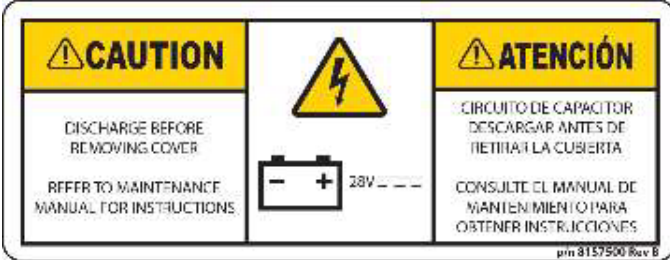
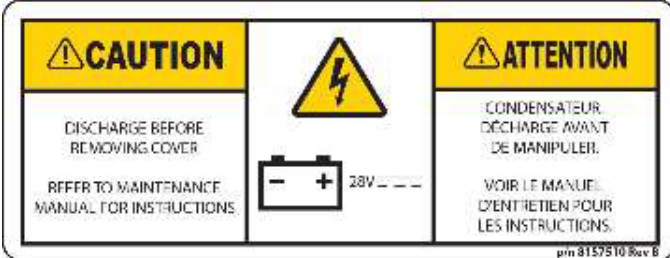
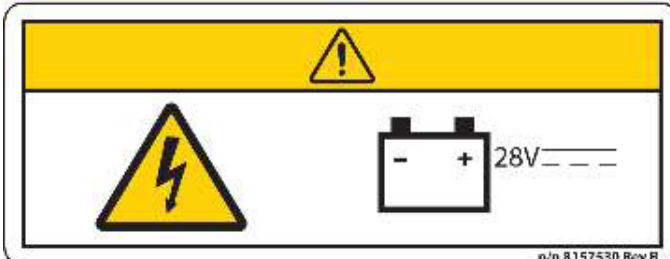



Label Locations	Description
	<p style="text-align: center;">US (8157500)</p> 
	<p style="text-align: center;">CA (8157510)</p> 
	<p style="text-align: center;">EU / AU / JP (8157530)</p> 

## 2.8.6.4. iBOT Chemical Hazard Label

**Location:** iBOT bottom safety cover (see Table 2-44).

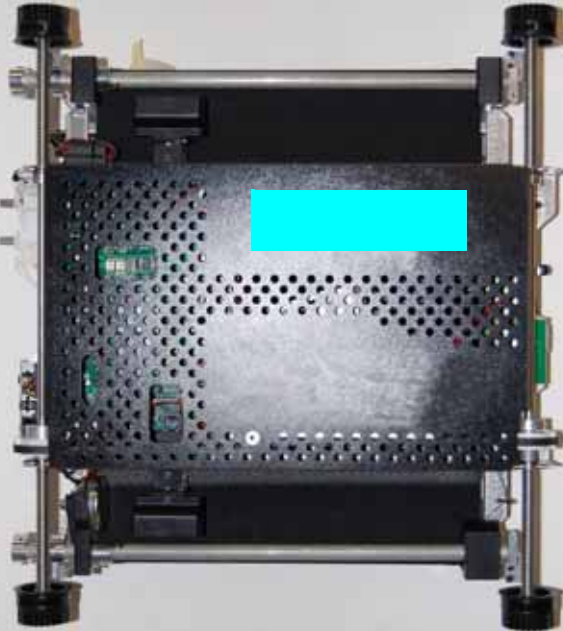
**Purpose:** Cautions personnel about hazardous substance contained inside. For additional information on ultra-capacitor safety, refer to [“Additional Product Safety Information” on page 89](#).

**Table 2-44: iBOT Chemical Hazard Label**



Label locations	Description
	<p style="text-align: center;">US (8156300)</p> 
	<p style="text-align: center;">CA (8156310)</p> 
	<p style="text-align: center;">EU / AU / JP (8156330)</p> 

## 2.8.6.5. iBOT Radio Compliance Label

**Location:** iBOT chassis rear, left (see Table 2-45).

**Purpose:** Acknowledges compliance with FCC & I.C. (or other governing body) rules and regulations.

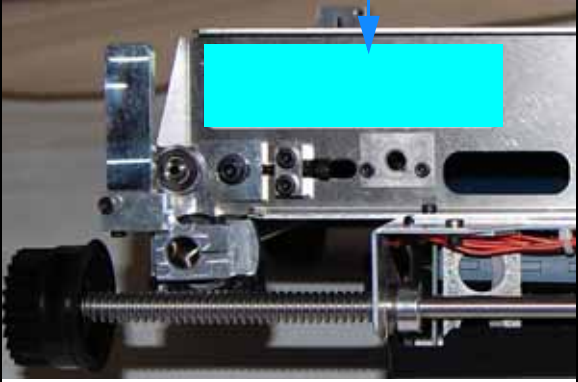
**Table 2-45: iBOT Radio Compliance Label**

Label Locations	Description
	<p>US / CA (7682610)</p> <div data-bbox="797 558 1446 720" style="border: 1px solid black; padding: 5px;">  <p>This device complies with Part 15 of the FCC rules. Operation is subject to the following two conditions: (1) this device may not cause harmful interference, and (2) this device must accept any interference received, including interference that may cause undesired operation.</p> <p><small>Contains FCC ID: VDM2054710 Contains IC: 7175A-2054710 Model: 205471010 OPEX® Corporation</small></p> </div> <p>EU / AU (N/A)</p> <p>Refer to the <b>CE-Mark</b> on the machine's Electrical Ratings Label</p> <p>JP only: MIC registration (7682640)</p> <div data-bbox="933 1241 1318 1367" style="text-align: center;">  <p><b>R 012-170046</b> Model: 2054710</p> </div> <p style="text-align: right; font-size: small;">P/n 7682640 Rev C</p>

## 2.9. Additional Product Safety Information



### Product Information Sheet

An MSDS is not required. This information sheet is provided as a service to our customers. An MSDS for the active chemical inside the listed products is available upon request. **For US Customers:** The products referenced herein are exempt articles and are not subject to the OSHA Hazard Communications Standard Requirement 29 CFR 1910.1200. **For EU Customers:** The products referenced herein are not submitted to 91-155 EEC, as they are considered as components and not as a chemical substance. **Notice:** The information and recommendations herein contained are made in good faith and are believed to be accurate at the date of preparation. Maxwell Technologies Inc. makes no warranty expressed or implied.

#### Product Information

<b>Manufacturer</b> Maxwell Technologies Inc. 9244 Balboa Avenue San Diego, CA 92123 Phone: 858-503-3300 Fax: 858-503-3333	<b>Product:</b> Ultracapacitors
EMERGENCY PHONE: North America Chemtrec Hazmat Communication Center 1 800 424 9300 + 1 703 527 3887 Europe Swiss Toxicological Information Centre +41 (0)44 251 5151	<b>Models:</b> All configurations and versions of PC5, PC10, PC5-5, BCAP0005 and BCAP0010
	<b>Date:</b> June 19, 2009
	Asia Chemtrec Hazmat Communication Center 1 800 424 9300 + 1 703 527 3887

#### Product Components

**Important Safety Note:** Ultracapacitors should not be opened, disassembled, crushed, burned, or exposed to high temperatures (>85°C, 185°F), and should be operated only within their defined operating specifications. Failure to adhere to operating specifications could result in poor device performance or unsafe operating conditions. Exposure to the components contained within the ultracapacitor could be harmful under certain circumstances. In case of exposure to ultracapacitor contents, wash affected area for at least 15 minutes with generous amounts of water and seek medical attention. Fires involving these types of ultracapacitors should be extinguished with CO<sub>2</sub>, dry chemical, alcohol foam, or all purpose AFFF extinguishing media. Water may be ineffective but should be used to cool fire-exposed containers, structures and to protect personnel.

BOOSTCAP® ultracapacitors are composed of the following major components:





Electrodes:	Activated Carbon
Separator:	Polypropylene or Cellulose
Electrolyte:	Quaternary salt (tetraethylammonium tetrafluoroborate) Organic solvent (acetonitrile)
Other:	Aluminum, steel

#### Disposal

BOOSTCAP ultracapacitors are neither specifically listed nor exempted from government hazardous waste regulations. The only material of possible concern is the organic solvent, which when discarded or disposed of, is a hazardous waste according to Federal regulations (40 CFR 261). It is listed as Hazardous Waste Number U003, so listed due to its toxicity and ignitability. Disposal can occur only in properly permitted facilities. Check state and local regulations for any additional requirements, as these may be more restrictive than federal laws and regulations.

#### Transportation

Ultracapacitors as articles are not specifically listed nor exempted from hazardous materials regulations (HMR). The U.S. Department of Transportation has provided Maxwell Technologies a written determination regarding Maxwell's PC5 and PC10 BOOSTCAP ultracapacitor products that the materials comprising the ultracapacitors are "...in a quantity and form that does not pose a hazard in transportation. Therefore, the ultracapacitors are not subject to the HMR."

 <b>Maxwell Technologies, Inc.</b> <b>Worldwide Headquarters</b> 9244 Balboa Avenue San Diego, CA 92123 USA Phone: +1 858 503 3300 Fax: +1 858 503 3301	 <b>Maxwell Technologies SA</b> CH-1728 Rossens Switzerland Phone: +41 (0)26 411 85 00 Fax: +41 (0)26 411 85 05	 <b>Maxwell Technologies GmbH</b> Brucker Strasse 21 D-82205 Gilching Germany Phone: +49 (0)8105 24 16 10 Fax: +49 (0)8105 24 16 19	 <b>Maxwell Technologies, Inc. - Shanghai Representative Office</b> Rm.2104, Suncome Liauw's Plaza 738 Shang Cheng Road Pudong New Area Shanghai 200120, P.R. China Phone: +86 21 5836 5733 Fax: +86 21 5836 5620
<b>info@maxwell.com – www.maxwell.com</b>			

Document #1004596.4



**RoHS3  
Certificate of Compliance**

7520 Mission Valley Road • San Diego, CA 92108-4400 • USA  
Tel: 619.398.9700 • Fax: 619.398.9797 • www.tecategroup.com

**Tecate Group RoHS 2002/95/EC  
Including Directives: 2011/65/EU (RoHS 2) &  
2015/863/EU (RoHS 3) Amendment to Annex II dated 3/31/16**

Tecate Group certifies that all of the products listed below comply with the requirements of the European Union’s Restriction of the Use of Hazardous Substances in Electrical and Electronic Equipment (“RoHS”) Directive 2002/95/EC, 2011/65/EU and the amendment to Annex II Directive 2015/863/EU dated 3/31/15 and contain less than the threshold percentages of the following substances:

Substance	RoHS Threshold
Cd (Cadmium)	100 ppm 0.01%
Cr VI (Hexavalent Chromium)	1000 ppm 0.1%
Hg (Mercury)	1000 ppm 0.1%
Pb (Lead)	1000 ppm 0.1%
PBBs (Polybrominated Biphenyls)	1000 ppm 0.1%
PBDEs (Polybrominated Diphenyl Ethers)	1000 ppm 0.1%
Bis(2-Ethylhexyl) phthalate (DEHP)	800 ppm 0.08%
Benzyl butyl phthalate (BBP)	800 ppm 0.08%
Dibutyl phthalate (DBP)	800 ppm 0.08%
Diisobutyl phthalate (DIBP)	800 ppm 0.08%

Certified By: James Kroessler

Signature:

Title: Director of Quality Assurance

Issue Date: October 24, 2017

RoHS3 General 20190716



7520 Mission Valley Road • San Diego, CA 92108-4400 • USA  
Tel: 619.398.9700 • Fax: 619.398.9797 • www.tecategroup.com

Products in this certification include:

CMC, CMC(HV), CMCF, CMCS, CMX, CSM, CMCS, CMS

931AF, 932A, 932D, 932AD, 932AF, 933AF, 932X, 933, 933X, 935X

CMR, CD, CMA, CMT

522, 522L, 522Z, 511

92, 92P, 2013S, 2014, 2014S, 2114, 2114Y, 814, 901, 902, 914, 914D, 2101, 2102, 9014, 9114, 2024, 2124, 2124V, 5124V, 7124, 924, 9245, 9245WT, 9247, MPX, MPXM, 2001, 2101, 2101V, 6001, 801, 901, 2012, 6002, 7102H, 7124, 7155, 902, 9024F, 9024R, 9023, 9024

MXEL, MXLH, MXLP, MXLX, MXLXH, MXM, MXMH, MXML, MXMS, MXNP, MXNW, MXS, MXNP, MXNW, MXS, MXW, MXWE, MXWH, MXWL, MXWM, MXWP, MXWRU, MXWX, MXZ, MXZH, MXZM, MXZX, MXZZ, LC, LCE, LG, LGE, 712, 712E, 712L, 724, 724E, 724L, 724S, 724SE, 724SL, 724X, 724Z, RN5, 711, 723, 725E, 725H, 725L, 725W, 725X, 728B, 728L, 730, 730W, 725R, TLL, TRC, TRE, TRS, TRZ, RN, RN7, RN7E, RNB, RNBE, RNH

MXCPA, MXCPB, MXCPH, MXCPP, MXCPT, CPL, CPS, CPU, CPX

PC, TPL, TPLE, TPLS

Ultracapacitor module types: PBM, TC, PBL, PBLE, PBL, PBL, PBLLE, PBD, PBL, PBL and PC5-5, TC.

All 17- Series ultracapacitor modules.

All 39- Series ultracapacitor cell.

All wire harnesses.

RoHS3 General 20190716



**The Components Group of Tecate Group Policy on European  
Registration, Evaluation, Authorization and Restriction of Chemicals  
(REACH) Legislation from the European Union (EU)**

**Preregistration and registration of substances in articles:** Tecate Group – Components Division (Capacitors and Ultracapacitors) does not currently supply any products that would be considered an article with a substance intended to be released during normal and reasonably foreseeable conditions of use. Tecate Group – Components Division therefore, does not have any plans for Registration or preregistration.

**Substances of Very High Concern (SVHC) under REACH:** Tecate Group – Components Division does not currently have any chemicals used in the production of part numbers included in this COC that are on the list of Substances of Very High Concern. Please see the specific lists on the following page.

Further, the parts covered in this COC do not contain any substances listed in REACH Annex XVII when used for the purposes listed in Annex XVII.

SVHC 201 publish date of 2019-07-16

I will be your REACH contact. If you have any questions, please contact me.

Certified By: James Kroessler  
[jimk@tecategroup.com](mailto:jimk@tecategroup.com)



Signature:  
Title: QA Manager

File: REACH\_201\_COC\_20190819



7520 Mission Valley Road • San Diego, CA 92108-4400 • USA  
Tel: 619.398.9700 • Fax: 619.398.9797 • www.tecategroup.com

Products in this certification include:

CMC, CMC(HV), CMCF, CMCS, CMX, CSM

931AF, 932A, 932D, 932AD, 932AF, 933AF, 932, 933, 933X, 935

CMR, CD, CMA

522, 522L, 522Z, 511

92, 92P, 2013S, 2014, 2014S, 2114, 2114Y, 814, 901, 902, 914, 914D, 2101, 2102, 9014, 9114, 914, 914D, 2024, 2124, 2124V, 5124V, 7124, 924, 9245, 9245WT, 9247, MPXM, 2001, 2101, 2101V, 6001, 801, 901, 2012, 6002, 7102H, 7124, 902, 9024F, 9024R

MXEL, MXLH, MXLP, MXLX, MXLXH, MXM, MXMH, MXML, MXMS, MXNP, MXNW, MXS, MXNP, MXNW, MXS, MXW, MXWE, MXWH, MXWL, MXWM, MXWP, MXWRU, MXWX, MXZ, MXZH, MXZM, MXZX, MXZZ, LC, LCE, LG, LGE, 712, 712E, 712L, 724, 724E, 724L, 724S, 724SE, 724SL, 724X, 724Z, RN5, 711, 723, 725E, 725H, 725L, 725W, 725X, 728B, 728L, 730, 730W, 725R, TLL, TRC, TRE, TRS, TRZ, RN, RN7, RN7E, RNB, RNBE, RNH

MXCPA, MXCPB, MXCPH, MXCPP, MXCPT, CPL, CPS, CPU, CPX

PC, TPL, TPLE, TPLS

Ultracapacitor module types: PBM, TC, PBL, PBLE, PBLL, PLLLE, PBD, PBLs and PC5-5, TC.

All 17- Series ultracapacitor modules.

All 39- Series ultracapacitor cells.

File: REACH\_201\_COC\_20190819

---

## 2.10. Machine Documentation

---

Machine documentation is provided in the holder located on the back of the input conveyor assembly (see Figure 2-23). Make sure to return the documents here for safekeeping when finished viewing them. To obtain replacement documents, contact OPEX Technical Support.

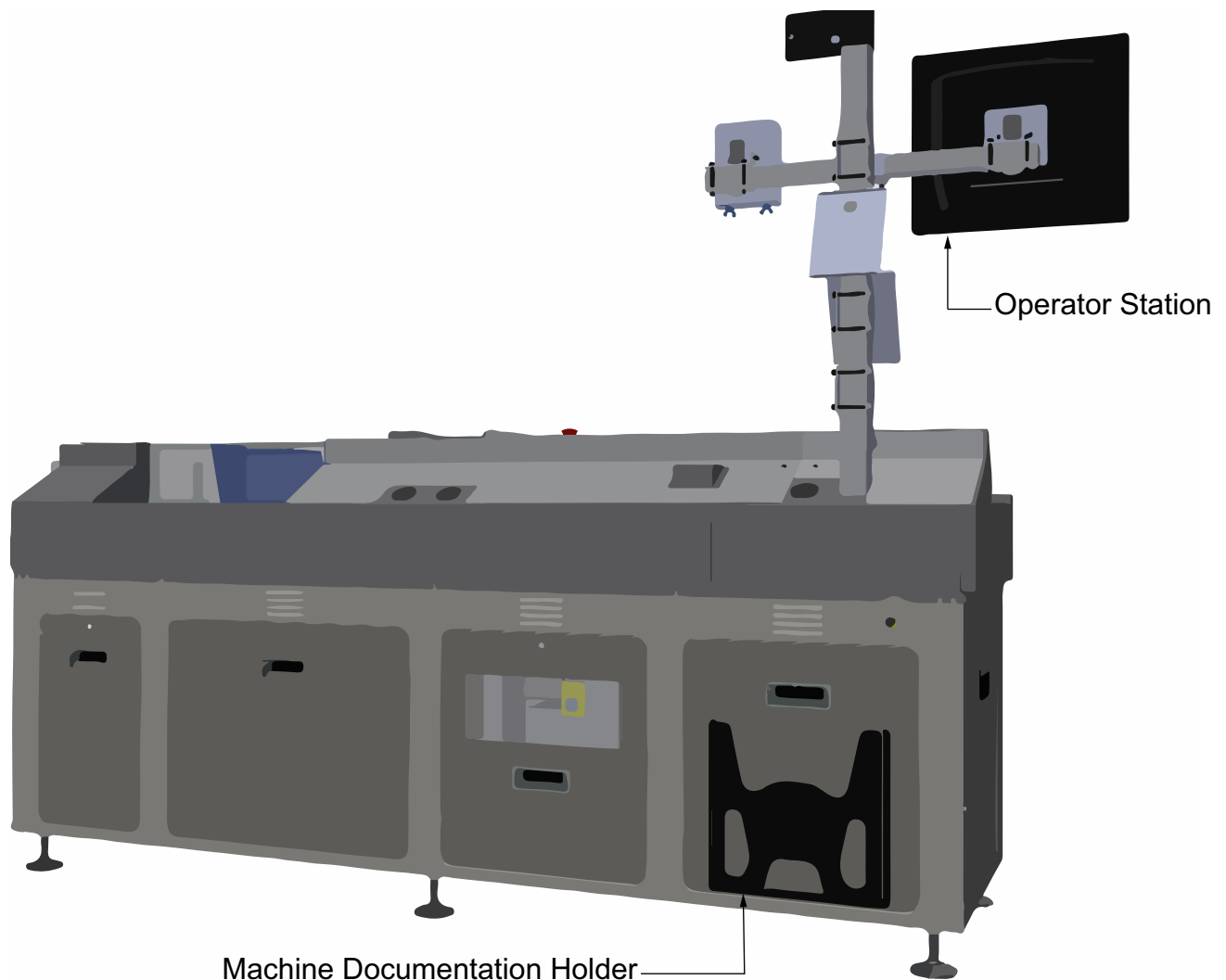

**Figure 2-23: Machine Documentation Holder**

**Note:** Please refer to [Chapter A: "Optional Right-Side \(200-Side\) Induction"](#) to view the location of the machine documentation holder for machines designed with the optional right-side input module.

# 3. System Overview

<b>3.1. Introduction</b> .....	<b>96</b>
<b>3.2. How the Sure Sort™ Works</b> .....	<b>103</b>
3.2.1. OPEX Host Software .....	104
3.2.2. OPEX Induct ELC .....	105
<b>3.3. Specifications</b> .....	<b>106</b>
3.3.1. Basic Configuration .....	106
3.3.2. Material Handling (Inventory Items) .....	106
3.3.3. Options .....	107
3.3.4. Module Dimensions .....	107
3.3.5. Environmental Specifications .....	108
<b>3.4. Equipment Layout and Required Floor Space</b> .....	<b>109</b>
<b>3.5. Electrical Requirements - North America</b> .....	<b>110</b>
<b>3.6. Electrical Requirements - Europe (EU)</b> .....	<b>111</b>
<b>3.7. Electrical Requirements - Japan</b> .....	<b>112</b>
<b>3.8. Regulatory Compliance Testing</b> .....	<b>113</b>
3.8.1. Standards that Equipment was Evaluated Against .....	113
3.8.2. FCC Standards: .....	114
<b>3.9. Equipment Serial Number Location</b> .....	<b>117</b>

**Sure Sort™**

**Operator Manual for Version 4.2 Machines**

## 3.1. Introduction

The OPEX Sure Sort™ is a robotic “each” or “piece” sorter that delivers a wide variety of items into a compact array of bin locations in a single pass.

Sure Sort uses a process combining induction, barcode scanning, verification, and delivery to automatically sort products required for order fulfillment. The main components involved in this process are illustrated below (see Figure 3-1). You can click on the [link](#) next to each component to view information about it, and on the ← to return to the main diagram of the machine.

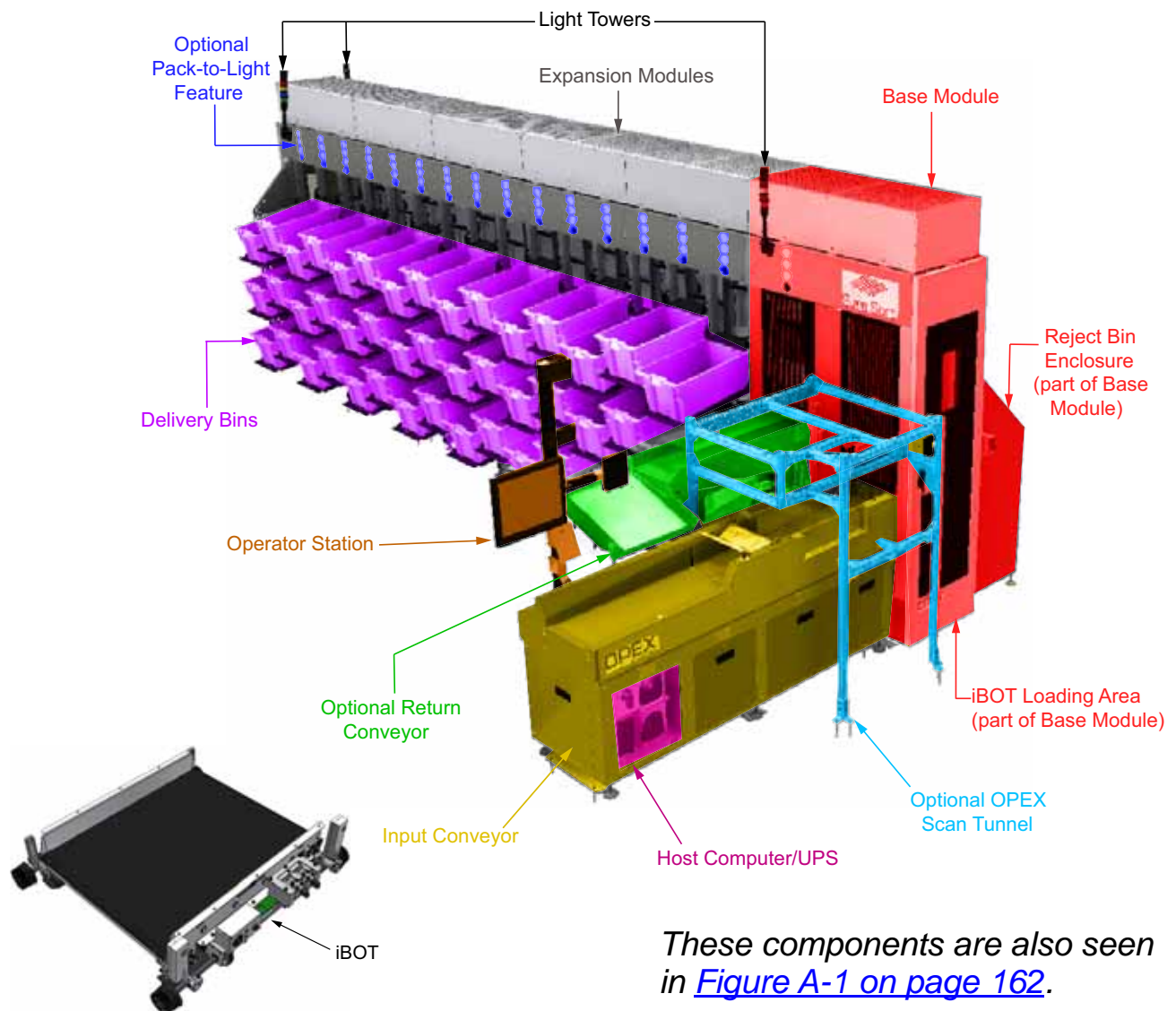
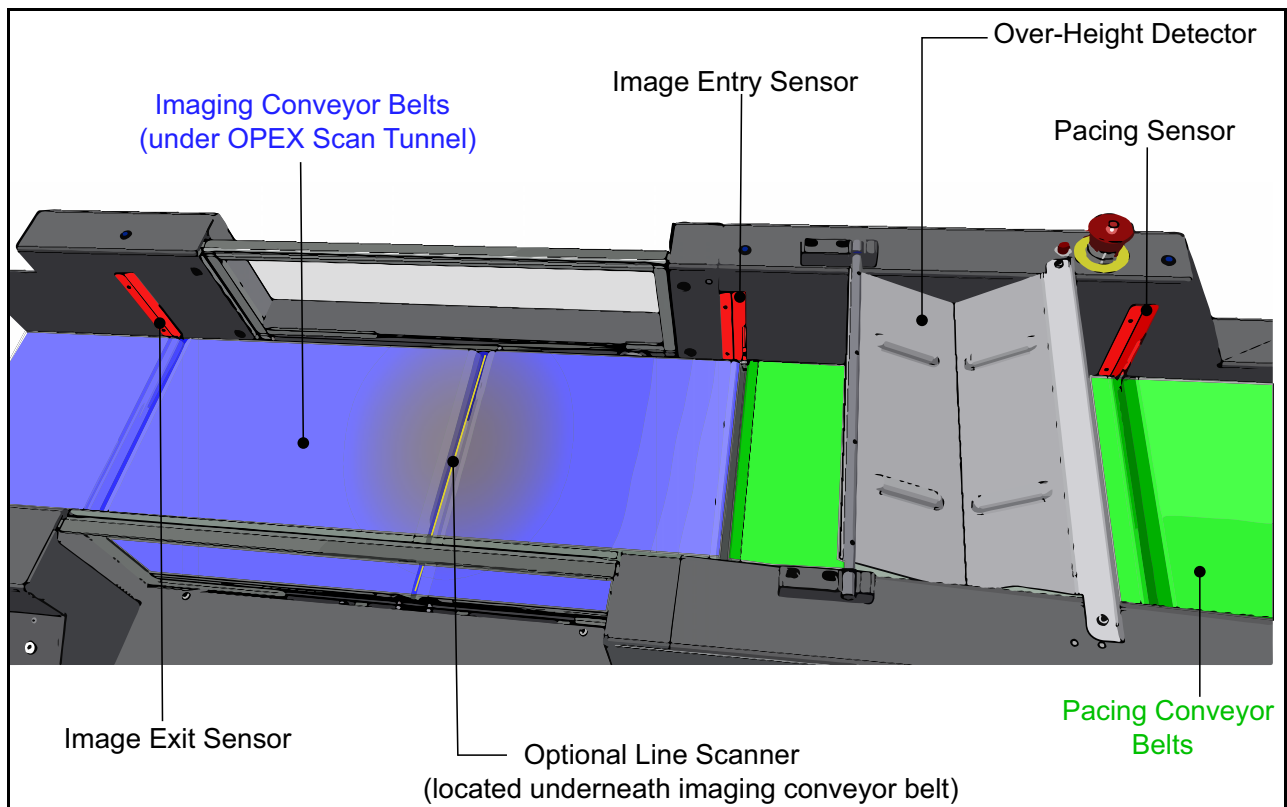

**Figure 3-1: Sure Sort - Main Components**

**The main components of the Sure Sort are described below:**

**Note:** An optional right-side induction is available. Please refer to [Chapter A: "Optional Right-Side \(200-Side\) Induction"](#) for more information.

**Input Conveyor** - The input conveyor consists of the pacing and imaging conveyor. It contains the operator station where items are placed, scanned for barcodes, and delivered onto the iBOTs in the base module. For optimal delivery, items are being paced automatically as fast as one item per second (see Figure 3-2). ←



**Figure 3-2: Input Conveyor Features**

**Operator Station** - A touch screen monitor allows you to operate the Sure Sort without using a mouse or keyboard. An optional single-scan camera or hand scanner is available here (see [page 102](#)). ←

**Host computer & UPS** - Microsoft® Windows10 pro / 64bit / 8Gb / Raid1 SSD drives. Host Computer contains Sure Sort Host Software and Induct ELC Software. UPS provides battery backup and surge protection. ←

**Induct ELC Software** - Enables easy integration with customers existing Warehouse Management Systems (WMS) to exchange item status and data for inventory tracking and order verification (see [“OPEX Induct ELC” on page 105](#) for further details). ←

**OPEX Scan Tunnel (Optional)** - An array of cameras used to read barcodes from items on the imaging conveyor, regardless of their orientation.

The scan tunnel uses up to seven cameras above the imager belts to find barcodes on the top, front, back, and sides of each item, and a line scan camera positioned under the gap between the two conveyor belts to find barcodes on the bottom (please refer to the “*OPEX Scan Tunnel Service Manual*” for further details).

One camera is assigned as the “master,” which is responsible for communication to/from the rest of the cameras (see Figure 3-3). The master receives a trigger signal from the I/O Control board via the Left Deluxe I/O box, and passes this trigger to the other cameras. Likewise, all other cameras pass their read results back to the master camera, which compiles the results and sends the data via RS232 to the Left Deluxe I/O box. The data is then routed to the ELC via the Host Computer’s Com Port 1.



**Figure 3-3: Barcode Scanners**



The Real-time Monitor (RTM) is the scan tunnel image processing computer located at the top of the tunnel (see Figure 3-4). It processes the images received by the line scan camera, extracts the barcode from these images, and sends the barcode data to the master camera. ←



**Figure 3-4: Scan Tunnel RTM Computer**

**Base Module -** The base module interfaces with the Input and Return conveyor, has a reject bin, E-Stop button, and one sort column. It is also where iBOTs are being charged and loaded into the Sure Sort. An interlocked access door allows entry by authorized service personnel. A second monitor enables the operator to Start and Stop the machine, clear jams, as well as troubleshoot issues. ←

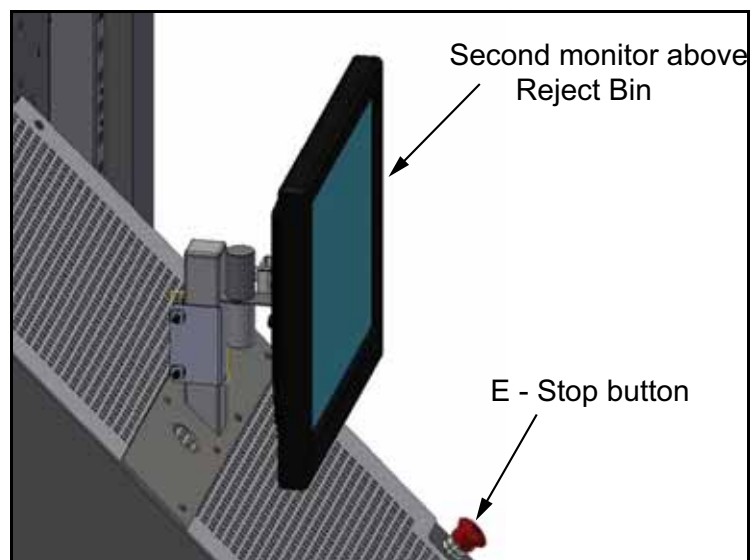

**Figure 3-5: Secondary Screen**

**iBOTs®** - Wireless robotic vehicles can effectively transport a variety of inventory up to five pounds.

- iBOTs can be added or removed easily to provide scalable throughput.
- iBOT power is recharged with every delivery cycle.
- The Sure Sort can support a total of 22 iBOTs. ←

**Return Conveyor (Optional)** - Motorized conveyor that returns items back to the operator for rescanning. Items that come back are mostly items that were not scanned properly. ←

**Light Towers** - The light towers alert the operator of the status of the Sure Sort. ←

**Expansion Module** - Each expansion module offers three columns per side. In these columns, the iBOTs travel along the tracks to deliver items to the bins. Up to 11 additional expansion modules can be installed to increase the bin capacity. ←

**Selection of Delivery Bins** - Available in depths of 4", 7" and 12" (10.16, 17.78 and 30.48 cm), based on customer requirements. The actual amount and size of bins are determined in the purchase agreement. ←

**Pack-to-Light System (Optional)** - The Pack-to-Light System (PTL) consists of LED lights that can be configured to prompt an operator when a bin needs attention. Order completion is managed by the customer's WMS, which informs the controller when to turn on the lights.

PTL can be programmed using up to 255 LED colors to indicate various bin states, such as: "bin full, bin not present, order complete," or to identify where a jam has occurred. The PTL lights can be programmed to appear in a continuous solid color, or to blink. They can also blink alternating between two colors.

The LED lights are currently available in two configurations:

- Bracket-mounted vertical LED strips (see Figure 3-6).



**Figure 3-6: Vertical LED Strips**

- LED-ring “stop lights” mounted above each bin column (see Figure 3-7).

The optional stop light feature provides up to four LED rings per column at the top of the machine that will light up to notify operators if a bin needs attention. Each light ring is made up of 12 LEDs and relates to a bin: The top ring will be for the top bin, second ring for the second bin, third ring for third bin, and if applicable, fourth ring for the fourth bin. If only three bins per column are used, then the fourth light ring is disabled. ←



**Figure 3-7: Stop Light Feature**

**Single Scan Camera (Optional)** - A single mounted camera option is available for use by the operator to scan barcodes (see Figure 3-8). ←



**Figure 3-8: Single Scan Camera**

**Hand Scanner (Optional)** - This option allows the operator to use a hand-held scanner for reading barcodes (see Figure 3-9). ←



**Figure 3-9: Hand Scanner**

---

---

## 3.2. How the Sure Sort™ Works

---

---

The Sure Sort™ system uses two software applications installed on the OPEX Host Computer to control and run the system: the Host software and the OPEX Induct ELC (External Link Component). Here's how they interact with the external Warehouse Management System (WMS):

1. An item is inducted into the system by the operator placing an item on the pacing conveyor belt.
2. The scan tunnel decodes the barcode and passes the result to the ELC.
3. The ELC passes the result to the Warehouse Management System (WMS).
4. The WMS responds to the ELC with a bin destination.
5. The ELC sends the bin destination to the OPEX Host software.
6. An iBOT delivers the item to the desired bin.
7. The host notifies the ELC that the piece has been delivered.
8. The ELC sends an acknowledgment to the WMS.

### 3.2.1. OPEX Host Software

The OPEX Host software provides the operator's main interface with the system's controls (see Figure 3-10). Use the Host software to start and stop the job, clear jams, remove/insert iBOTs, run diagnostic tests, and view statistical reports. Behind the scenes, the OPEX Host software communicates with the Controller (INtime). The Host is the operator interface, and the Controller is what is actually running the machine (e.g. gates, motors, iBOT movement). The Host also communicates with the OPEX Induct ELC.

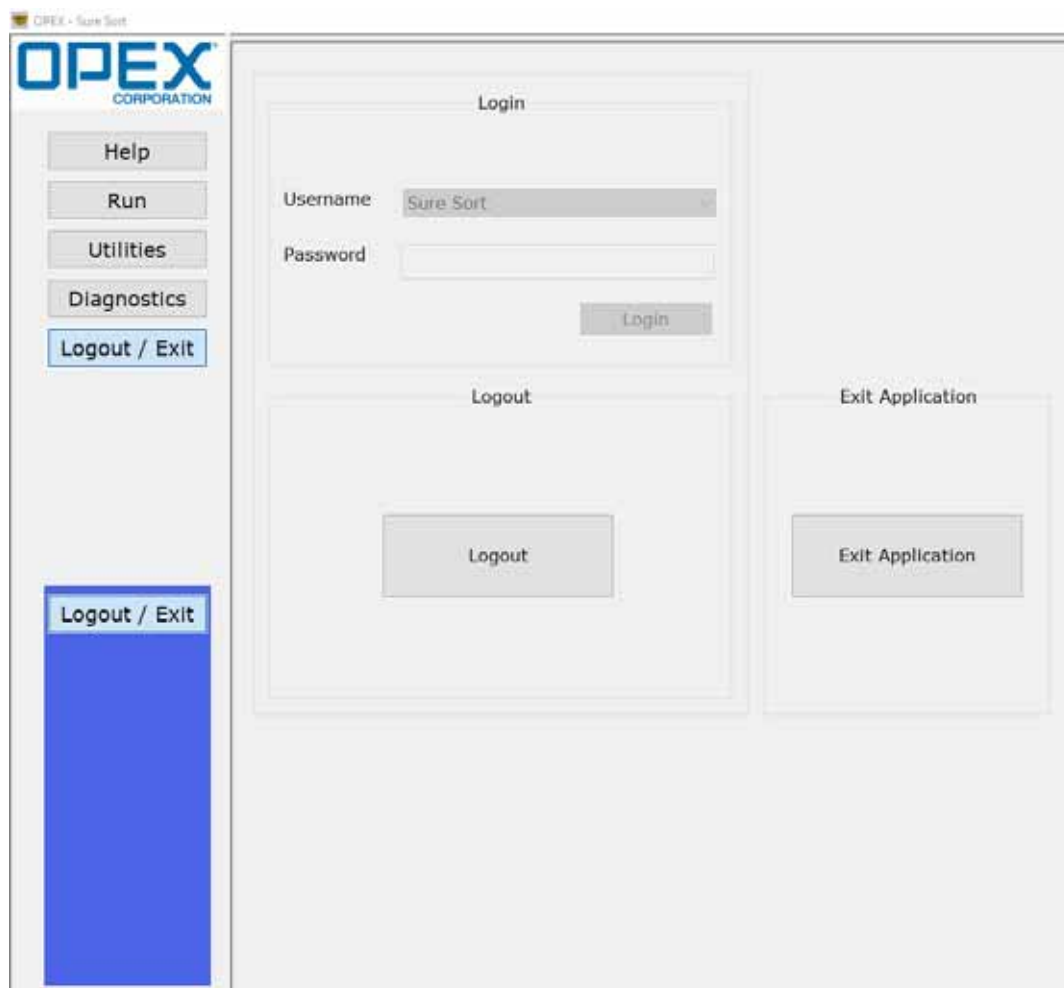

**Figure 3-10: Host Software Interface**

### 3.2.2. OPEX Induct ELC

The OPEX Induct ELC (External Link Component) is a separate application which interfaces between the Sure Sort host application and the WMS (see Figure 3-11). The ELC communicates with the WMS to receive bin destinations. The bin destination is sent to the host, and the host directs an iBOT to deliver the piece to the desired bin. The Induct ELC also communicates with the optional scanners (the OPEX scan tunnel, wand, and fix-mount scanner).

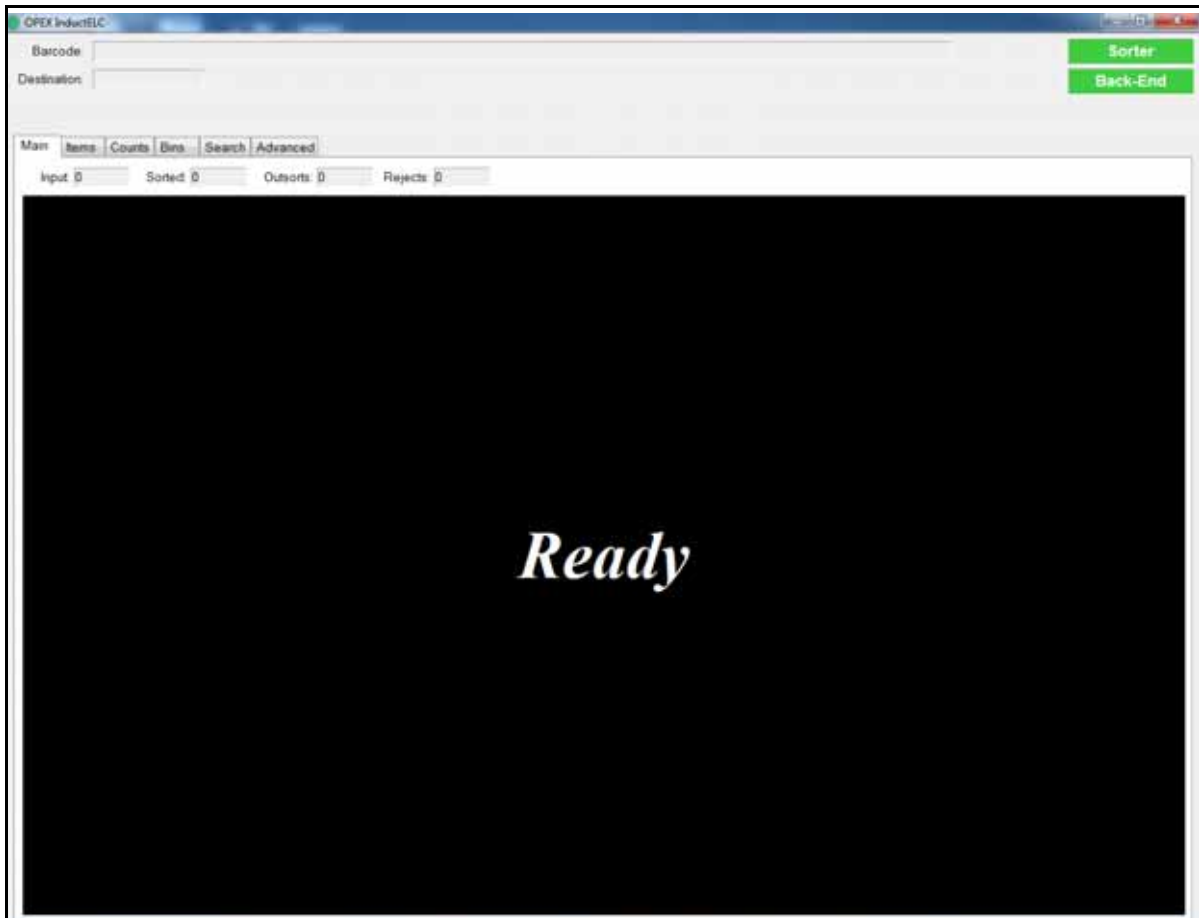

**Figure 3-11: OPEX Induct ELC - Main Screen**



---

---

## 3.3. Specifications

---

---

### 3.3.1. Basic Configuration

<b>Length</b>	<ul style="list-style-type: none"><li>• Up to 555.6" (14.11 m) with 11 expansion modules</li><li>• 105" (2.7 m) for each additional expansion module</li></ul>
<b>Width</b>	<ul style="list-style-type: none"><li>• 132" (3.35 m) at the Input conveyor</li></ul>
<b>Height</b>	<ul style="list-style-type: none"><li>• 102" (2.6 m) w/light tower</li></ul>
<b>Footprint</b>	See <a href="#">"Equipment Layout and Required Floor Space" on page 109.</a>
<b>Electrical</b>	See <a href="#">"Electrical Requirements - North America" on page 110;</a> <a href="#">"Electrical Requirements - Europe (EU)" on page 111;</a> <a href="#">"Electrical Requirements - Japan" on page 112.</a>

### 3.3.2. Material Handling (Inventory Items)

<b>Length</b>	2" to 15" (5.08 cm to 38.1 cm)
<b>Width</b>	2" to 12" (5.08 cm to 30.5 cm)
<b>Height</b>	0.007" to 4.0" (0.018 cm to 10.16 cm)
<b>Weight</b>	Up to 5 lbs. (2.27 kg)

### 3.3.3. Options

<b>iBOTS</b>	Up to 22
<b>Delivery Bins</b>	4" (10.16 cm), 7" (17.78 cm), 12" (30.48 cm)
<b>Throughput</b>	Scalable up to 3,600 items/hour
<b>Barcode Readers</b>	<ul style="list-style-type: none"> <li>• 6-Sided Automated OPEX scan tunnel</li> <li>• Fixed Mount Reader</li> <li>• Hand Scanner</li> </ul>
	Items recalled by WMS are returned for secondary action
<b>Pack-to-light (PTL)</b>	Customizable LED indicators (example, bin full or order complete)
<b>Expansion Modules</b>	Up to 11

### 3.3.4. Module Dimensions

Module	Width	Length	Foot-print	Height	Std. Weight	Installed Weight	Weight / Sq. Ft.
Input conveyor	24" (60.96 cm)	82" (208.28 cm)	13.7 ft <sup>2</sup> (1.27 m <sup>2</sup> )	71" (180.34 cm)	714 lbs (323.87 kg)	714 lbs (323.87 kg)	33 lb/ft <sup>2</sup> (161.12 kg/m <sup>2</sup> )
Base	34.5" (87.63 cm)	58.5" (148.59 cm)	14.0 ft <sup>2</sup> (1.30 m <sup>2</sup> )	89" (226.06 cm)	668 lbs (303 kg)	1160 lbs* (526.17 kg)	83 lb/ft <sup>2</sup> (405.24 kg/m <sup>2</sup> )
Expansion	57" (144.78 cm)	44.5" (113.03 cm)	17.6 ft <sup>2</sup> (1.64 m <sup>2</sup> )	89" (226.06 cm)	220 lbs (99.79 kg)	2058 lbs* (933.49 kg)	117 lb/ft <sup>2</sup> (571.24 kg/m <sup>2</sup> )
Return conveyor	25.5" (64.77 cm)	68.5" (173.99 cm)	12.2 ft <sup>2</sup> (1.13 m <sup>2</sup> )	46" (116.84 cm)	215 lbs (97.52 kg)	215 lbs (97.52 kg)	17.8 lb/ft <sup>2</sup> (86.91 kg/m <sup>2</sup> )
Scan tunnel	39.5" (100.33 cm)	39.5" (100.33 cm)	10.8 ft <sup>2</sup> (1.00 m <sup>2</sup> )	60" (152.40 cm)	161 lbs (73.03 kg)	161 lbs (73.03 kg)	14.9 lb/ft <sup>2</sup> (72.75 kg/m <sup>2</sup> )

**Note:** Weights marked with an asterisk (\*) include a maximum of 350 lbs per column per side, or 50 lbs of product per bin at 7 bins per column per side if anchored to the floor. Otherwise, the maximum per-column weight is 100 lbs.

### 3.3.5. Environmental Specifications

<b>Agency approvals</b>	TÜV Rheinland (for U.S. and Canada), CE, FCC
<b>Noise emissions</b>	<p>Average exposure levels based on multi-position sound measurements taken of a Sure Sort with 11 expansion modules.*</p> <ul style="list-style-type: none"> <li>• Overall range: 78.4 dB - 60.1 dB Leq</li> <li>• Operator station (Input module front): 74.3 dB Leq</li> </ul> <p>*Full sound test report available upon request.</p>
<b>Operating, Transportation and Storage Temperatures</b>	<p>Operating: 40° to 90°F (4° to 32°C)            Transport: -20° to 140°F (-29° to 60°C)            Storage: 32° to 100°F (0° to 38°C)</p>
<b>Humidity</b>	40% to 95% RH
<b>Maximum operating altitude</b>	<2000m

## 3.4. Equipment Layout and Required Floor Space

The System Footprint below shows the required floor space (see Figure 3-12).

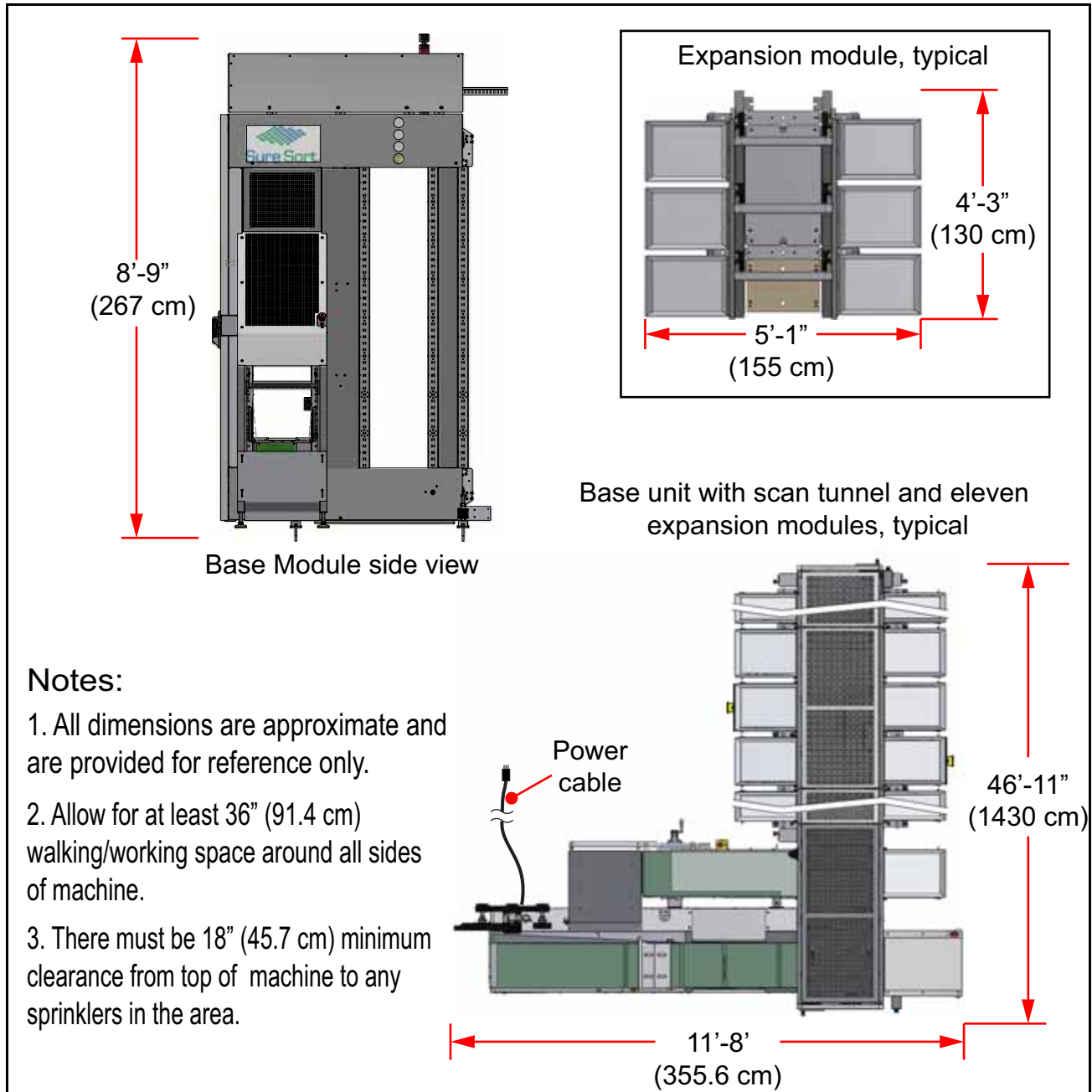

**Figure 3-12: System Footprint**

**Note:** Please refer to [Chapter A: "Optional Right-Side \(200-Side\) Induction"](#) to view the equipment layout for machines designed with the optional right-side input module.

## 3.5. Electrical Requirements - North America

North American Sure Sort units require an AC line voltage of 120/208 VAC, single phase, 60Hz (2 Lines + Neutral + Ground to Earth).

- Line to Line voltage = 208VAC (+6%/-10%)
- Line to Neutral voltage = 120VAC (+6%/-10%)

The machine is supplied with a 15 ft. (4.57 m) length of 10/4 SO cord, and NEMA locking plug L14-30P, connected to the AC distribution enclosure of the Induct conveyor module.

The customer must provide a 30 Amp maximum circuit breaker-protected circuit using a NEMA rated L14-30R locking receptacle (Hubbell HBL2713 or equivalent). See North American plug and receptacle diagram in Figure 3-13.

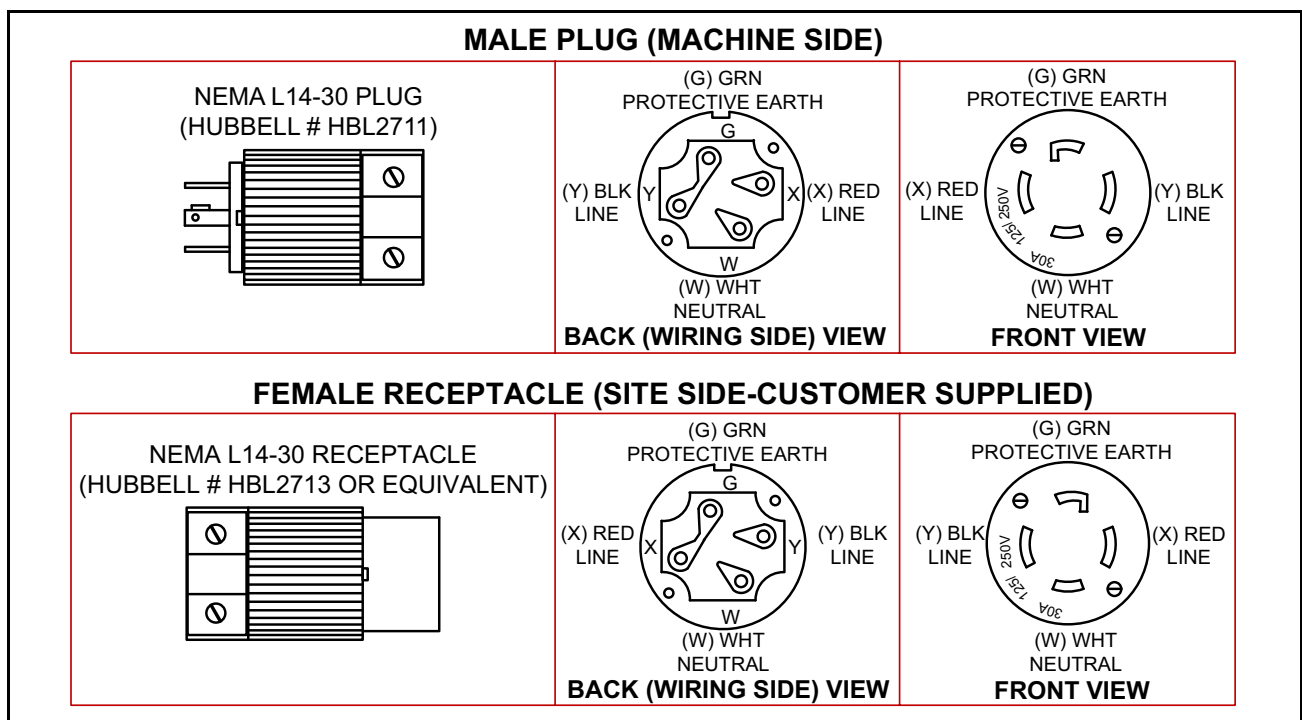

**Figure 3-13: North American Plug & Receptacle Requirements**

## 3.6. Electrical Requirements - Europe (EU)

European Sure Sort units require an AC line voltage of 230 VAC, 1-phase, 50 Hz (Line + Neutral + Protective Earth).

- Line to Neutral voltage = 230VAC (+/-10%)

The machine is supplied with a 15 ft. (4.6 m) length of 10/3 HAR Cord with an IEC 309 Pin type plug (Walther Electric #230306), connected to the AC distribution enclosure of the Induct conveyor module.

The customer must provide a 32 Amp maximum circuit breaker-protected circuit.

For plug and receptacle installations, use an IEC 309 Sleeve type receptacle (Walther Electric #330306 or equivalent). See European (EU) plug and receptacle diagram in Figure 3-14.

For hard-wired installations, remove the supplied plug and wire directly to a disconnect switch that meets local electrical codes.

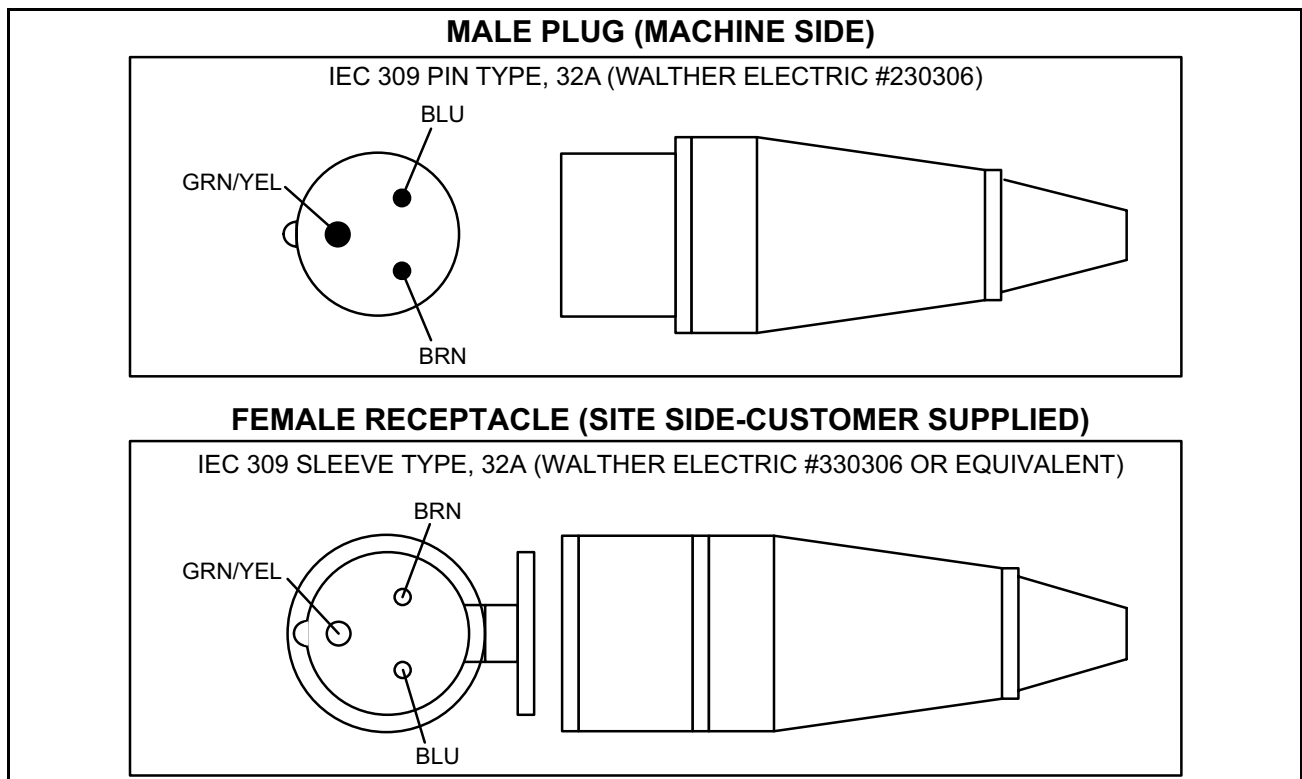

**Figure 3-14: European (EU) Plug & Receptacle Requirements**

## 3.7. Electrical Requirements - Japan

East Japan machines require AC line voltage of 200 VAC (+/-10%), and 50 Hz.

West Japan machines require AC line voltage of 200-210 VAC (+/-10%), and 60 Hz.

Refer to specifications for both plug-receptacle machines and hard-wired machines in Figure 3-15.

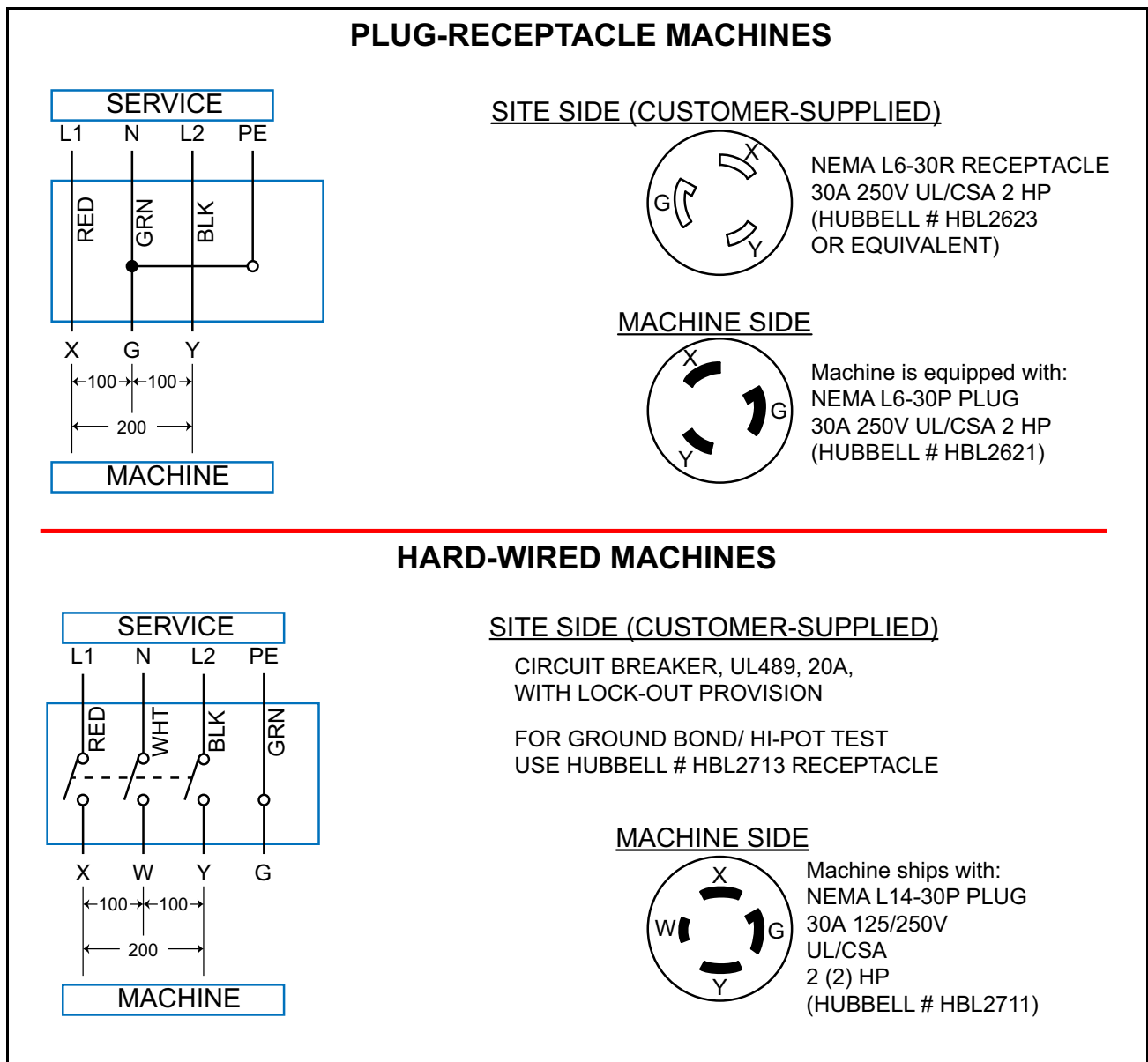

**Figure 3-15: Japan Electrical Requirements**



## 3.8. Regulatory Compliance Testing

**Note:** As Sure Sort is tested against local and international standards, we will update this listing.

### 3.8.1. Standards that Equipment was Evaluated Against

2006/42/EC	Machinery Directive
2014/53/EU	Radio Equipment Directive
2014/30/EU	Electromagnetic Compatibility Directive
EN 61000-6-2: 2005	Electromagnetic compatibility (EMC). Generic standards. Immunity for industrial environments
EN 61000-6-4: 2011	Electromagnetic compatibility (EMC) -- Part 6-4: Generic standards - Emission standard for industrial environments
EN 619: 2002+A1:2010	Continuous handling equipment and systems. Safety and EMC requirements for equipment for mechanical handling of unit loads
EN ISO 12100-2:2003	Safety of machinery - Basic concepts, general principles for design - Part 2: Technical principles
EN 60204-1:2006+A1:2009	Safety of machinery. Electrical equipment of machines. General requirements
ETSI EN 300 328 V2.1.1 (2016-11)	Wideband transmission systems; Data transmission equipment operating in the 2,4 GHz ISM band and using wide band modulation techniques; Harmonised Standard covering the essential requirements of article 3.2 of Directive 2014/53/EU
ETSI EN 301 489-1 V1.9.2 (2011-09)	Electromagnetic compatibility and Radio spectrum Matters (ERM); ElectroMagnetic Compatibility (EMC) standard for radio equipment and services; Part 1: Common technical requirements
NFPA 79:2018	Electrical Standard for Industrial Machinery

<b>2006/42/EC</b>	<b>Machinery Directive</b>
UL 2011:2006	Outline of Investigation for Factory Automation Equipment
CSA C22.2 No. 301-2016	Industrial electrical machinery
UL 61800-5-1 (iBOT only)	Standard for Adjustable Speed Electrical Power Drive Systems: Safety requirements - Electrical, Thermal and Energy
IEC 61508:2010 parts 1-7	Functional safety of electrical/electronic/ programmable electronic safety-related systems - Part 1: General requirements Part 2: Requirements for electrical/electronic/ programmable electronic safety-related systems Part 3: Software requirements Part 4: Definitions and abbreviations Part 5: Examples of methods for the determination of safety integrity levels Part 6: Guidelines on the application of IEC 61508- 2 and IEC 61508-3 Part 7: Overview of techniques and measures

### 3.8.2. FCC Standards:

FCC 47CFR PT 15.247 - Operation within the bands 902-928 MHz, 2400-2483.5 MHz, and 5725-5850 MHz.

FCC 47CFR PT 15 SPT B - Title 47 CFR Part 15 Subpart B: Unintentional Radiators

RSS 210 - Low Power Licence-Exempt Radiocommunication Devices (All Frequency Bands) - Category I Equipment

#### **FCC Information / Informations FDD**

This device complies with Part 15 of the FCC Rules. Operation is subject to the following two conditions: (1) this device may not cause harmful interference,

and (2) this device must accept any interference received, including interference that may cause undesired operation.

The wireless transceiver antennae must not be modified or, replaced with that of a different type.

Changes or modifications not expressly approved by OPEX Corporation could void the user's authority to operate the equipment.

Module cannot be co-located with other antenna or transmitter except as specified in the grant condition of equipment authorization; other electronic functions not associated with the certified module or certified transmitter may require additional equipment authorization. The module should not be marketed and sold in a way that have to be end-user accessible/replaceable. A host product is required to comply with all applicable FCC equipment authorizations regulations, requirements and equipment functions not associated with the transmitter module portion. To ensure compliance with all non-transmitter functions the host manufacturer is responsible for ensuring compliance with the module(s) installed and fully operational.

Operators and persons nearby the equipment will maintain a minimum 20 cm (8") separation distance from device antenna.

### **FCC ID VDM2054710 Model 2054710**

Cet appareil est conforme à la partie 15 des règles de la FCC. Son fonctionnement est soumis aux deux conditions suivantes: (1) ce dispositif ne doit pas causer d'interférences nuisibles, et (2) cet appareil doit accepter toute interférence reçue, y compris les interférences qui peuvent provoquer un fonctionnement indésirable.

Les antennes d'émission-réception sans fil ne doit pas être modifié ou remplacé par celui d'un autre type.

Les changements ou modifications non expressément approuvés par OPEX Corporation pourraient annuler l'autorité de l'utilisateur à utiliser l'équipement.

Module ne peut pas être co-localisé avec autre antenne ou émetteur, sauf comme indiqué dans l'état de la délivrance de l'autorisation de l'équipement; d'autres fonctions électroniques ne sont pas associés avec le module émetteur certifié ou certifié peuvent exiger une autorisation de matériel supplémentaire. Le module ne doit pas être commercialisé et vendu d'une manière qui doivent être l'utilisateur final accessible / remplaçable. Un produit d'accueil est tenu de se conformer à toutes les autorisations applicables FCC d'équipement

règlements, des exigences et des fonctions de l'équipement ne sont pas associés avec la partie de module émetteur. Pour assurer la conformité avec toutes les fonctions non-émetteur le fabricant hôte est responsable d'assurer la conformité avec le module (s) installé et pleinement opérationnel.

Les utilisateurs et les personnes à proximité de l'équipement seront de maintenir un minimum de 20 cm (8 ") de la distance de séparation de l'antenne de l'appareil.

### **Industry Canada Information / Industrie Canada l'information**

According to RSS-Gen Issue 4 Section 8.3:

This radio transmitter IC: 7175A-2054710 has been approved by Industry Canada to operate with the antenna types listed below with the maximum permissible gain indicated.

Antenna types not included in this list, having a gain greater than the maximum gain indicated for that type, are strictly prohibited for use with this device.

Internal antenna: Inverted F PCB (gain: 2.2 dBi); or,

External antenna: Digi-International A24-HASM-450 (gain 2.14 dBi)

According to RSS-Gen Issue 4 Section 8.4:

This device complies with Industry Canada's license-exempt RSSs. Operation is subject to the following two conditions:

1. This device may not cause interference; and
2. This device must accept any interference, including interference that may cause undesired operation of the device.

Selon RSS-Gen Numéro 4 Section 8.4:

Cet appareil est conforme aux CNR exempts de licence d'Industrie Canada. Son fonctionnement est soumis aux deux conditions suivantes:

1. Ce dispositif ne peut causer des interférences; et
2. Ce dispositif doit accepter toute interférence, y compris les interférences qui peuvent causer un mauvais fonctionnement de l'appareil.

IC : 7175A-2054710 Model 2048910

## 3.9. Equipment Serial Number Location

Before contacting OPEX Technical Support, the Authorized Employee should locate the Service Tag on the machine so that they can provide the assisting OPEX Technician with the machine Serial Number (see Figure 3-16) and/or iBOT serial number (see [Figure 3-17 on page 118](#)).

Please refer to [page 2](#) for contact information.

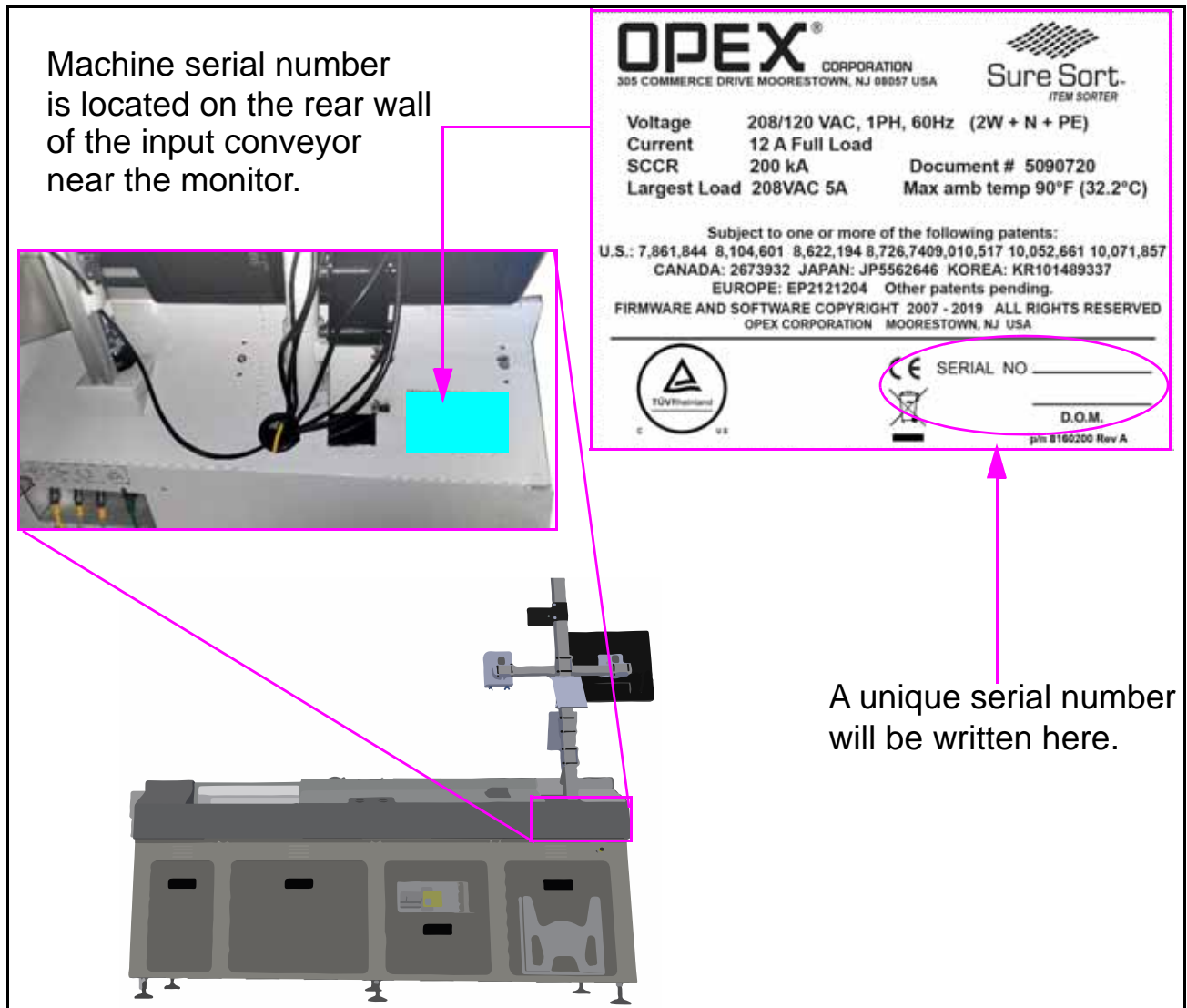

**Figure 3-16: Machine Serial Number Location**

**Note:** Please refer to [Chapter A: "Optional Right-Side \(200-Side\) Induction"](#) to view the location of the equipment serial number for machines designed with the optional right-side input module.

The iBOT Serial Number label can be found on the front and rear of the iBOT chassis:

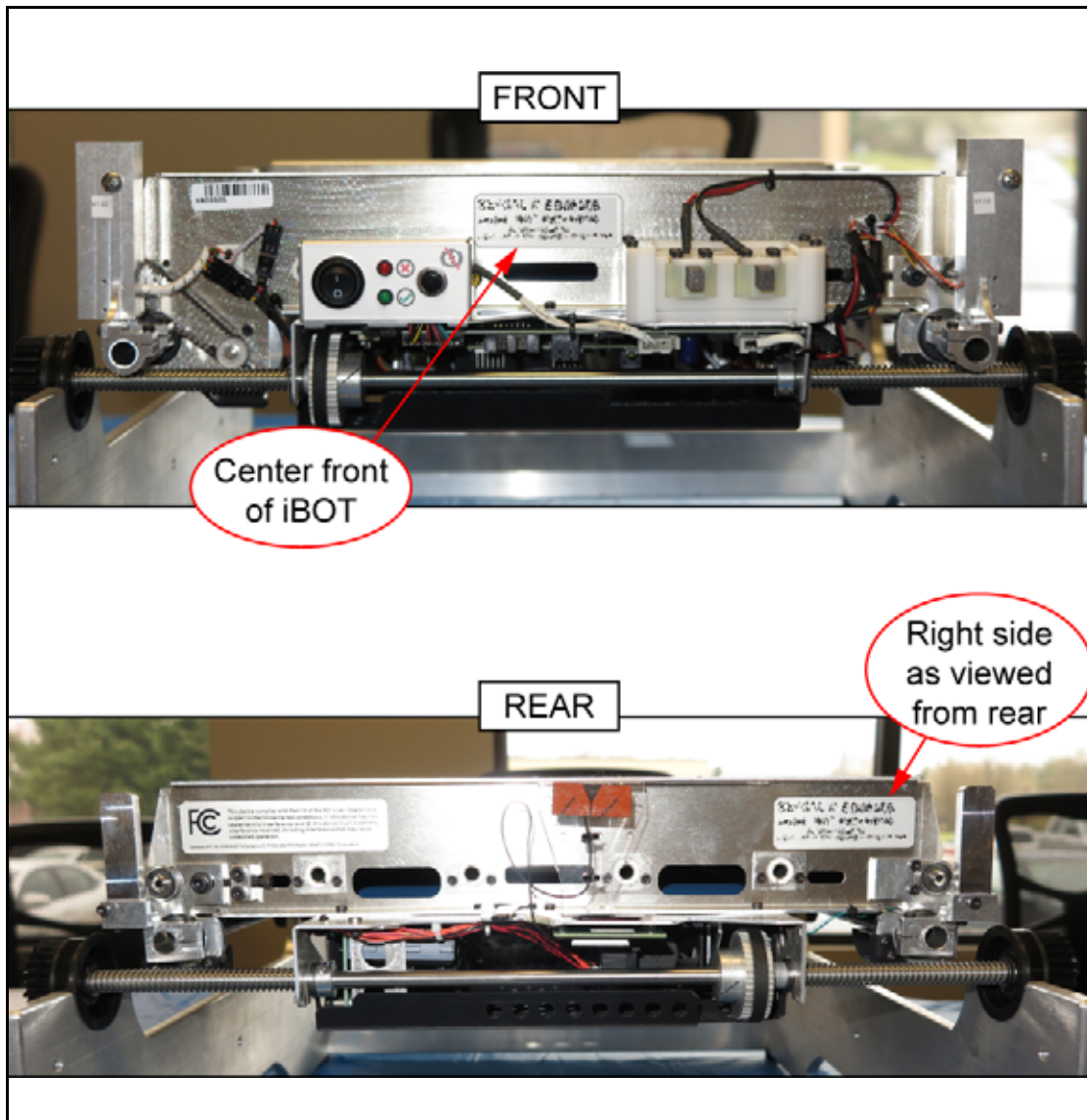

**Figure 3-17: iBOT Serial Number Location**



# 4. Operation

<b>4.1. Introduction</b> .....	<b>120</b>
<b>4.2. Turning the Power ON/OFF</b> .....	<b>121</b>
<b>4.3. Logging in to the Host Software</b> .....	<b>122</b>
<b>4.4. Navigating the Host Software</b> .....	<b>124</b>
4.4.1. Run Screen Details .....	126
4.4.2. Clearing Jams & Other Warnings .....	129
4.4.3. Product-Related Jams .....	135
<b>4.5. Starting the Machine &amp; Running a Job</b> .....	<b>137</b>
4.5.1. Starting the Machine .....	137
4.5.2. Feeding Items into the Machine .....	138
4.5.3. Scanning Items Manually .....	142
<b>4.6. Stopping the Machine &amp; Exiting the Job</b> .....	<b>145</b>

**Sure Sort™**

**Operator Manual for Version 4.2 Machines**



## 4.1. Introduction



### WARNING

Read and follow all safety precautions and procedures in [Chapter 2: "Safety"](#) before attempting to operate, service or troubleshoot this equipment.

Most functions of the Sure Sort™ system are accessible from the operator station, where the operator is within easy reach of the conveyor and the primary touchscreen monitor (see Figure 4-1). The host computer displays the screens for the operator's main interface with the Sure Sort™ system.

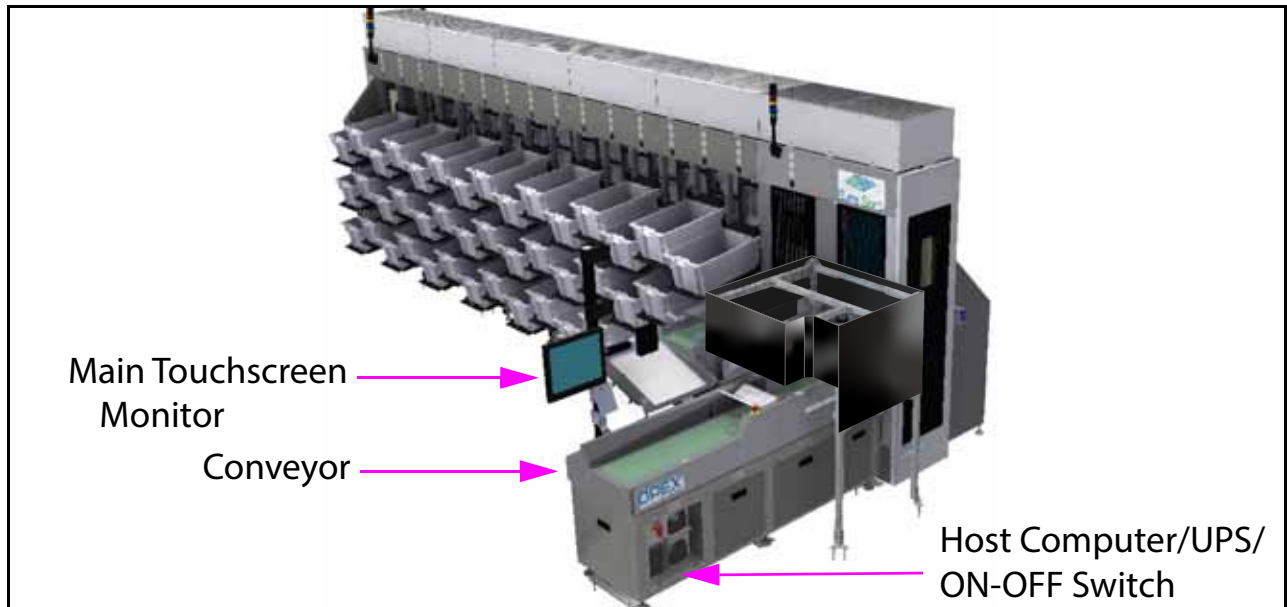

**Figure 4-1: Operator Station - Left-Side Induction**

**Note:** For further details on the main components of the Sure Sort, please refer to [page 96](#).

### NOTICE

The optional mirror-inverted right-side induction does not affect the functionality of the components or operational procedures of the machine.

---

---

## 4.2. Turning the Power ON/OFF

---

---

### How to power up the machine:

1. Confirm that the red handle of the main disconnect switch found within the cabinet is in the ON position (see Figure 4-2). If it is in the Off position, as described in [“LOTO - Machine Maintenance and Repair” on page 33](#), check to see if anyone is working on the machine before attempting to power up.

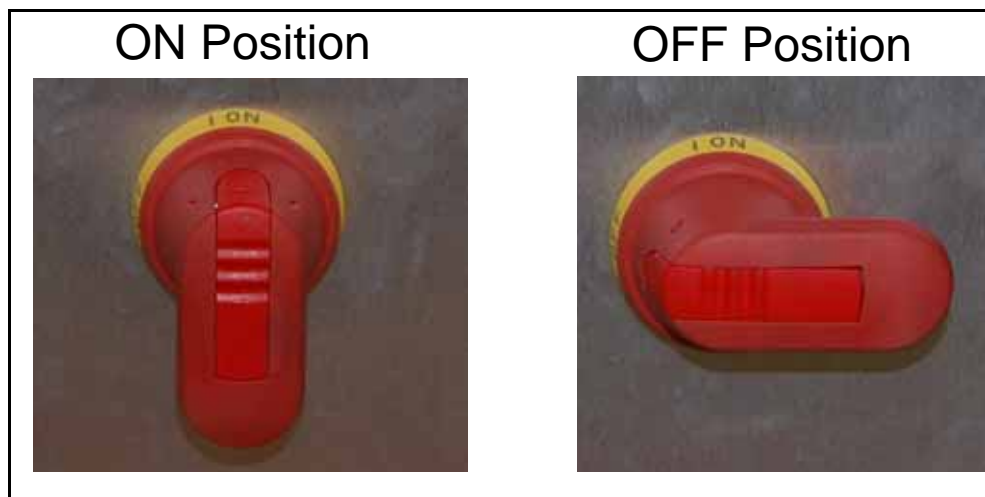

**Figure 4-2: Main Disconnect Switch Handle - On/Off Positions**

2. Press the Power button on the front of the UPS. The host computer should start with the UPS. If not, press the power button on the front of the host computer.
3. Log in to Windows at the operator station using the touchscreen monitor.

### How to power down the machine:

1. Finish the job, and log out or simply close the host software.
2. Shut down the host computer.
3. Press the Power button on the UPS.
4. Turn the red main disconnect switch handle to the Off position.

---

## 4.3. Logging in to the Host Software

---

The Sure Sort™ host computer will launch the Host software as well as the OPEX Induct ELC software, as part of the system's start-up routine. If you mistakenly closed the Host or OPEX Induct ELC software, or if the Host or OPEX Induct ELC software does not start with the machine, you can start it manually:

If the Host software is not already running, double-click on the Sure Sort™ icon (see Figure 4-3) on the desktop OR click **Start > Programs > OPEX > Sure Sort™** to open it.

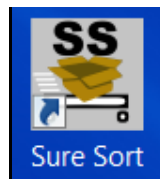

**Figure 4-3: Sure Sort Desktop Icon**

When the Sure Sort Host application is started, you are automatically logged into the Host, and a default job is selected. This will take you to the Run Screen on start-up (see Figure 4-4), where you can manage your run (for more info on the run screen, go to [page 126](#)).

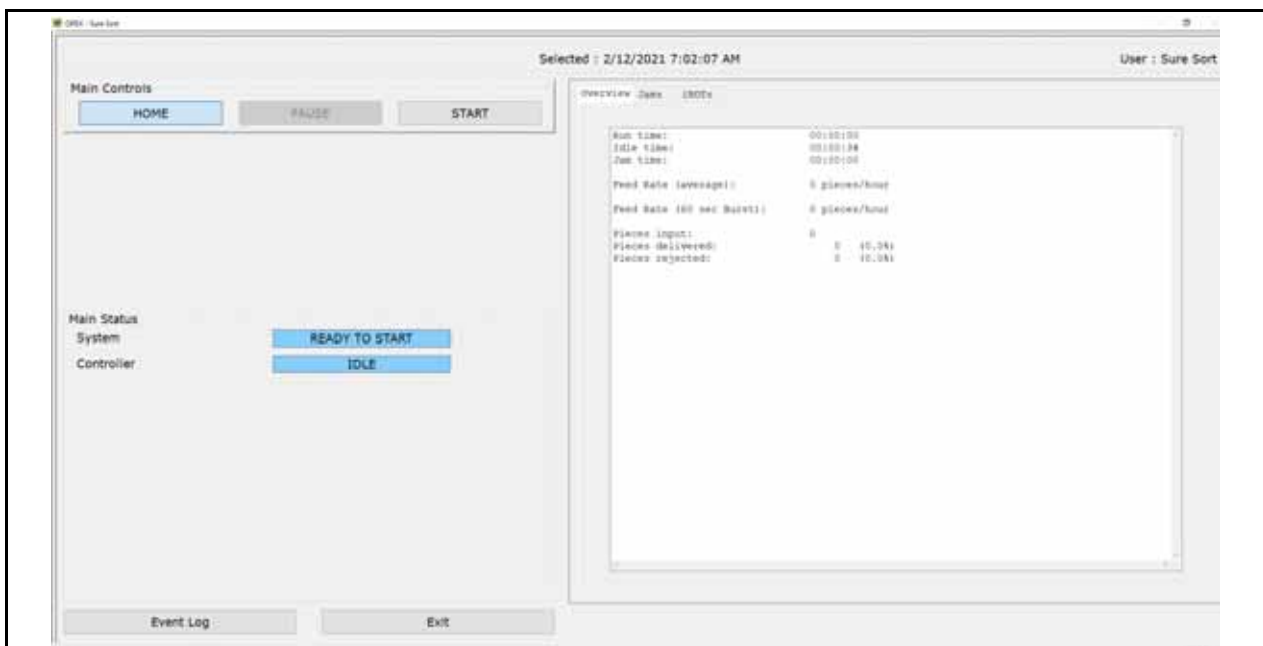

**Figure 4-4: Run Screen**

If the OPEX ELC Induct software is not already running, double-click on the OPEX InductElc icon (see Figure 4-5) on the desktop OR click Start > All Programs > OPEX > InductELC > OPEX InductElc to open it.

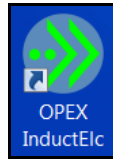
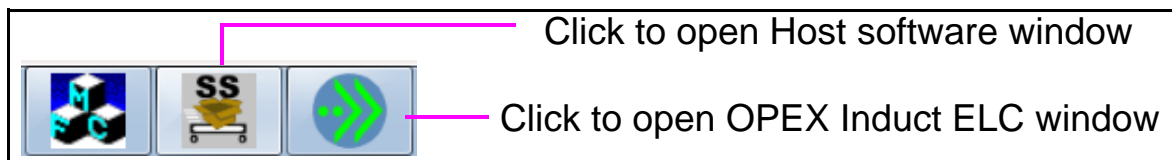

**Figure 4-5: OPEX Induct ELC Icon**

### How to toggle between the Host & Induct ELC Software:

Because the host software and the OPEX Induct ELC software need to be opened to operate the Sure Sort, this overlapping of software packages can sometimes be confusing. It's possible to “lose sight” of one of the software screens, whether they are hidden behind each other, or minimized.

The easiest way to toggle between the software packages when they are both open is to press the **Alt + Tab** keys. You can also click on the icons in the taskbar at the bottom of the screen to bring up that software (see Figure 4-6).



**Figure 4-6: Sure Soft Taskbar**

If the Host software was minimized, click the **Restore** button (see Figure 4-7).

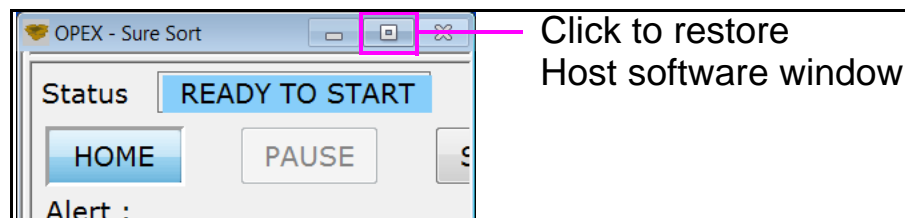
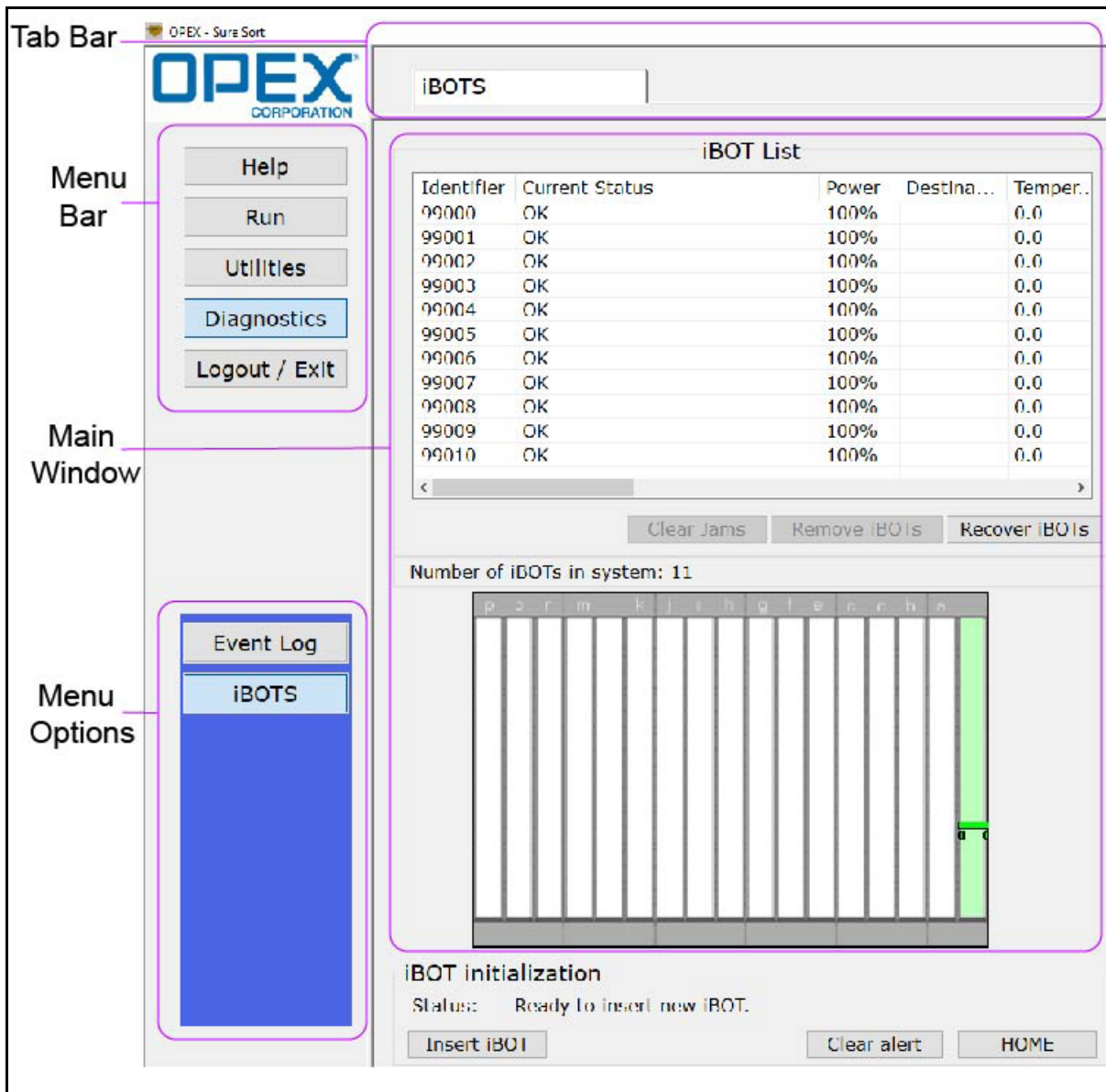

**Figure 4-7: Host Software - Restore Button**

## 4.4. Navigating the Host Software

The Sure Sort™ Host software provides the main interface with the system's controls. Use the Host software to start, run and stop the job.

The components of the Host software interface are illustrated below (see [Figure 4-8](#)) and described on the following page:



**Figure 4-8: Host Software Interface**

**Menu bar** The vertical menu bar provides access to the main system functions. Select a category from the menu bar and make selections from the main window or the menu options bar. The default user will have limited access to settings and features while logged in. The following features are available for the operator:

- Help menu
- Run Screen
- Utilities menu
- Diagnostics menu
  - Event Log
  - iBOTs (the default operator will be able to use the main iBOTs tab, but will be unable to access any of the iBOT's files).
- Logout/Exit

**Menu options** The menu options provide sub-categories for the selections in the menu bar. The menu options bar will change based on the current menu bar selection.

**Tab bar** Some screens will have tabs, which break the screen down into different categories. Click on the different tabs to access the various settings.

**Main window** View and adjust settings and make selections in the main window.

## 4.4.1. Run Screen Details

Click **Run** in the Menu Bar to open the *Run Screen*.

**Use the Run Screen to:**

- Start and stop the job
- View vital system information about the job as the machine is running
- View information about jams
- View information about the iBOTs

There are three main components to the Run Screen: the main controls, the main status area, and the information tabs (see Figure 4-9).

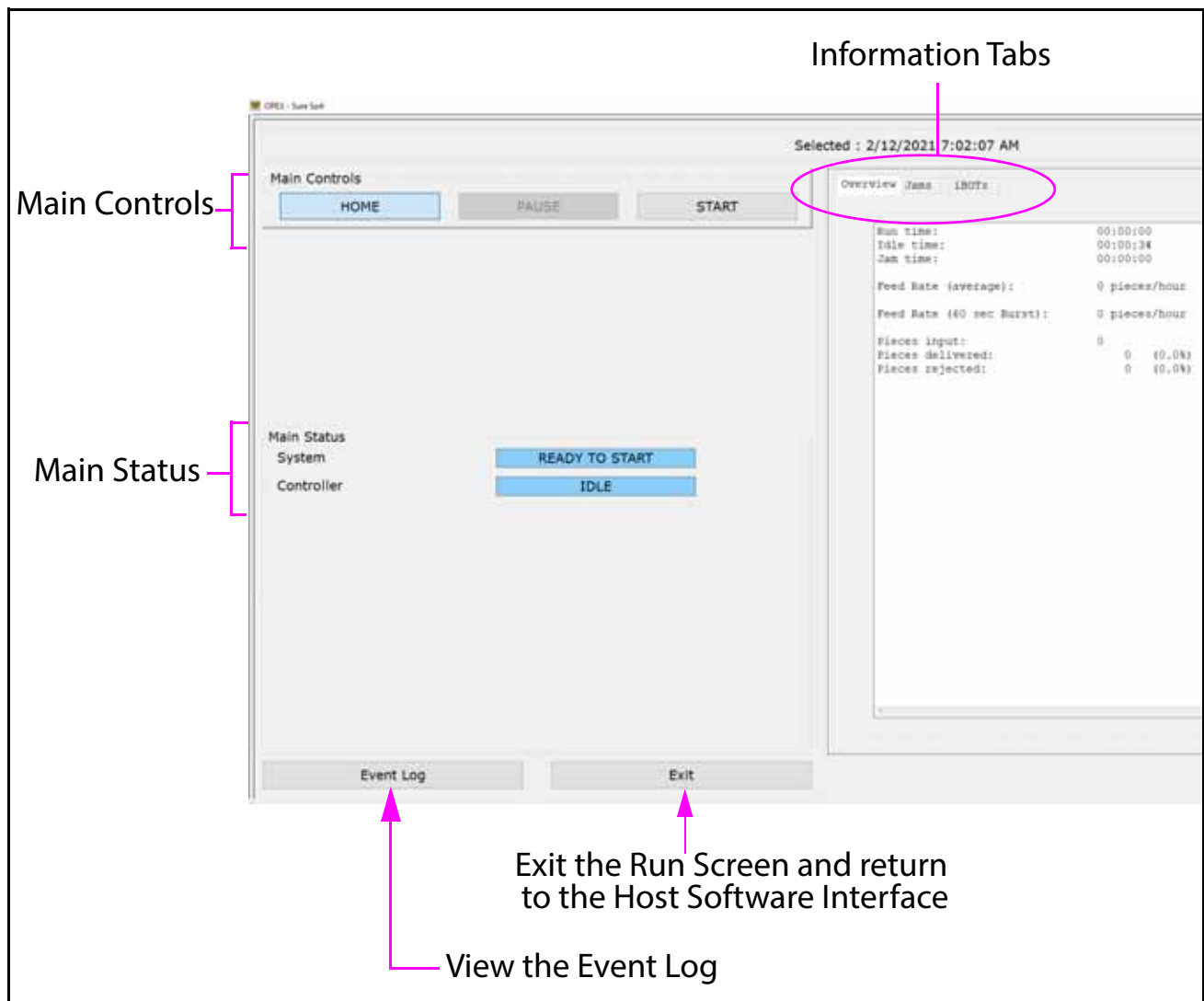

**Figure 4-9: Run Screen Components**



### 4.4.1.1. Information Tabs

The information tabs on the right side of the Run Screen provide information about the machine and its performance during the run. The default user will have limited access to settings and features while logged in. Features that are available in the information tab section are listed below:

#### 4.4.1.1.1. Overview Tab

The Overview tab provides information about the current run (see Figure 4-10).

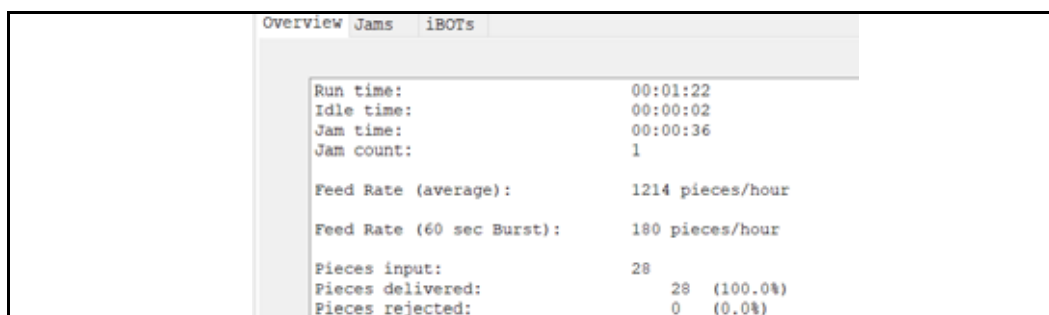

**Figure 4-10: Overview Tab**

<b>Run time</b>	Total time spent processing items.
<b>Idle time</b>	Time the operator spent with the Run screen open without a job running.
<b>Jam time</b>	Total time the system was halted for a jam.
<b>Jam count</b>	Reports occasions when run was halted due to a jam or a processing problem that was machine related.
<b>Feed rate (average)</b>	Total number of items fed into the system, per hour.
<b>Feed rate (60 sec Burst)</b>	Feed rate during the last 60 seconds.
<b>Pieces input</b>	Total number of items fed into the system. Pieces rejected + Pieces delivered should equal Pieces input.
<b>Pieces delivered</b>	Number of items successfully delivered to a bin.
<b>Pieces rejected</b>	Number of items rejected.

**Note:** Other fields displayed are irrelevant for the Sure Sort.

### 4.4.1.1.2. Jams Tab

Lists jams that have occurred during the current run (see Figure 4-11).

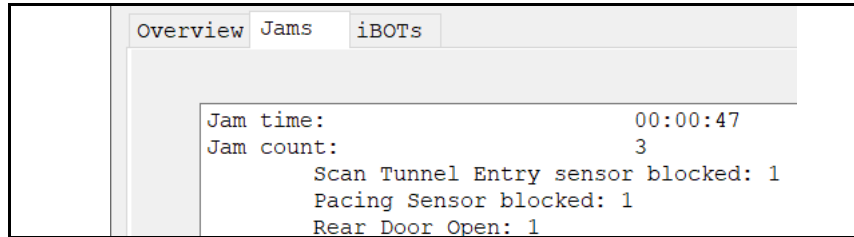
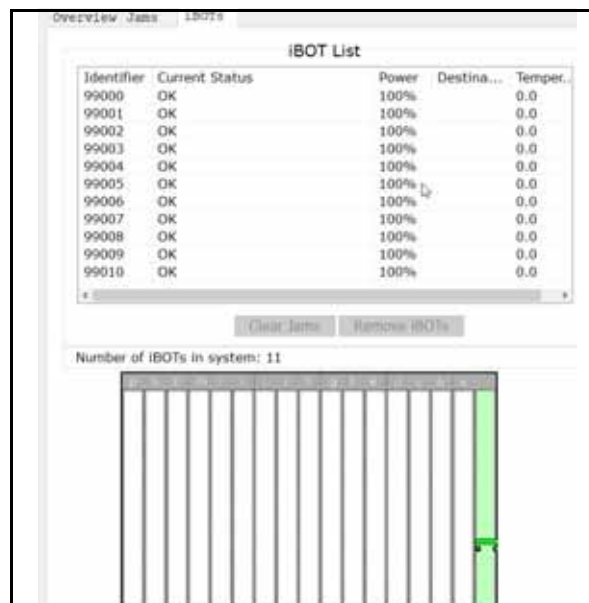

**Figure 4-11: Jams Tab**

<b>Jam time</b>	Total time the system was halted for a jam.
<b>Jam count</b>	Reports occasions when run was halted due to a jam or a processing problem that was machine related.

### 4.4.1.2. iBOTS Tab

The iBOTS tab provides information about each active iBOT (see Figure 4-12). The tab includes a status report for each iBOT, including its power level, destination bin, motor-temperature, as well as a graphical display of the system. The example below, shows the iBOTS parked at the front column, while the machine is idle.





**Figure 4-12: iBOTS Tab**

## What the display shows:

The graphical display at the bottom of the iBOTs tab shows exactly where in the system each active iBOT is at any time during the run. The green column on the far right represents the loading column.

The color of each iBOT indicates its current status (see Figure 4-13):

	(Green) The iBOT is sufficiently charged
	(Yellow) The iBOT is in need of attention (low on power)
	(Red) The iBOT has jammed

**Figure 4-13: iBOT Colors Used in Graphical Display**

A white rectangle on top of an iBOT indicates that the iBOT is carrying an item.

**Note:** Click on an iBOT in the display to see its status information in the top window.

### 4.4.2. Clearing Jams & Other Warnings

From time-to-time, you will experience the inevitable jam. A “jam” refers to any occurrence that causes the machine to stop, not necessarily because an item is physically jammed in the machine. A jam can also refer to a lost iBOT.

This section refers to many of the common, easily-fixed jams that may occur from time-to-time when running the machine.

#### **NOTICE**

If an iBOT has become stuck in the machine (or is otherwise unusable) and needs to be removed, inform your supervisor, or contact an Authorized Employee or OPEX technician.

When a jam occurs, the Run Screen will alert you as to where the jam has taken place (see Figure 4-14).

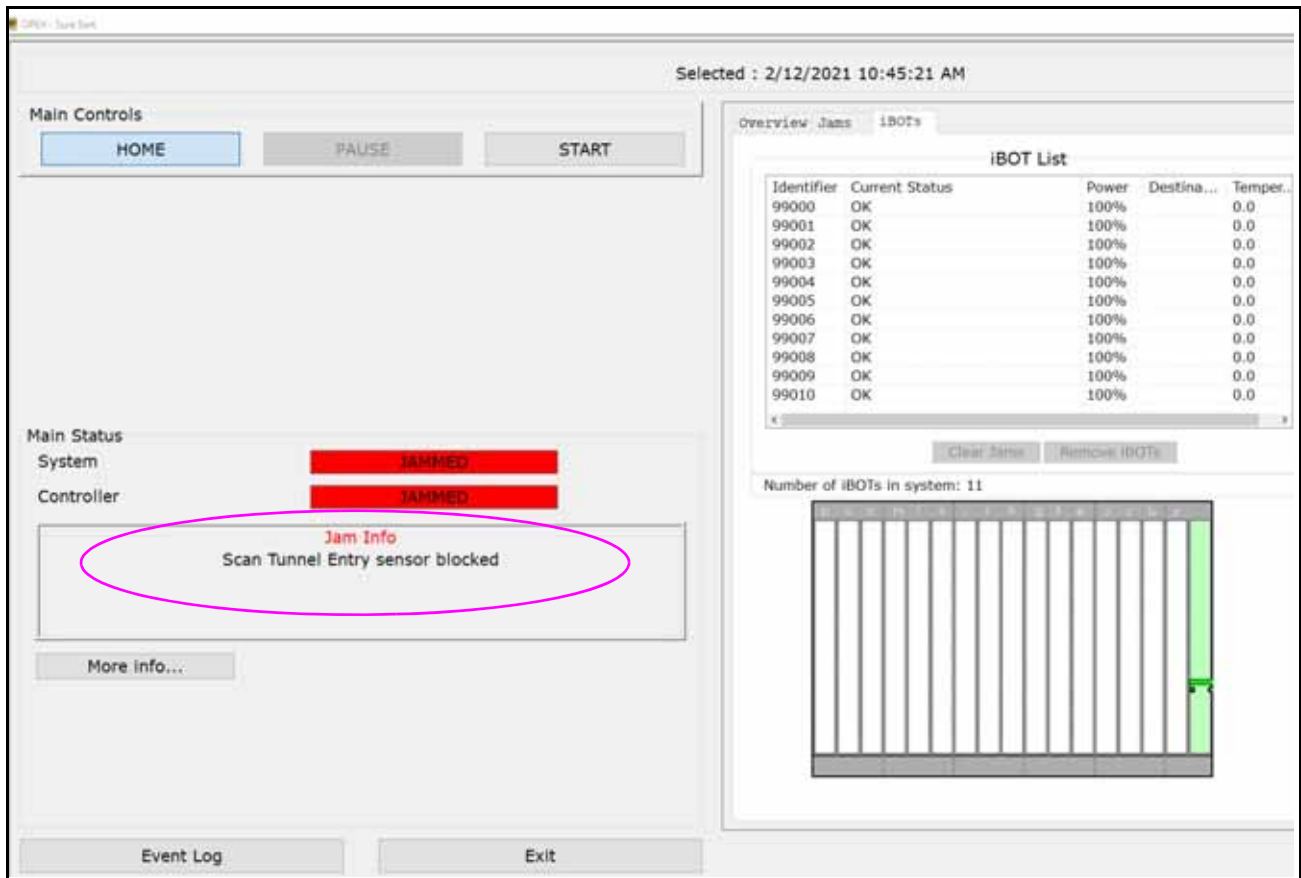

**Figure 4-14: Run Screen Jam Notification Example**

Press the **More Info...** button (see Figure 4-15) to get a detailed description about the jam and what can be done to clear it. The **Authorized Employee** will clear the jam and press **START** on the Run Screen to continue.

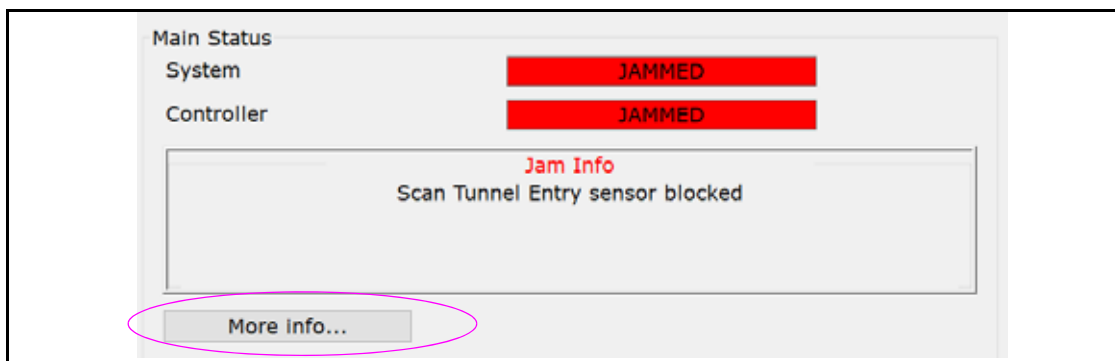

**Figure 4-15: "More Info..." Button**

### 4.4.2.1. Load Failure Jams

The system will call a load failure jam when an item does not arrive on the iBOT in the specified amount of time. This jam can occur when an item is late or, for some reason, does not make it to the awaiting iBOT at all.

### 4.4.2.2. Missed/Blocked Sensor Jams

The system will also halt for a jam, if an item does not arrive at a specific place at a specific time. For example, items should reach the imaging conveyor within a certain range of time. If not, the system assumes that something is wrong and the machine will stop (see Figure 4-16).

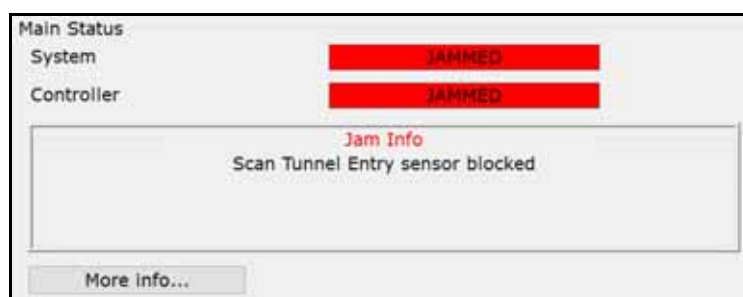

**Figure 4-16: Sensor Blocked Jam**

**Note:** Another common example of a missed sensor jam occurs when an iBOT delivers an item to a bin and the item misses the iBOT’s exit sensor on its way out.

### 4.4.2.3. Fan Failure Jams

A fan is used to regulate the temperature of each iBOT’s track motor. When the fan fails, the system will jam to prevent a damage to the motor due to overheating (see Figure 4-17).



**Figure 4-17: Fan Failure Jam**

#### 4.4.2.4. Motor Temperature Exceeded Max. Limit Jams

A thermistor is used to monitor the temperature of each iBOT's track motor. When the temperature of the motor exceeds its maximum operating temperature, the machine will jam to prevent a damage to the motor (see Figure 4-18).

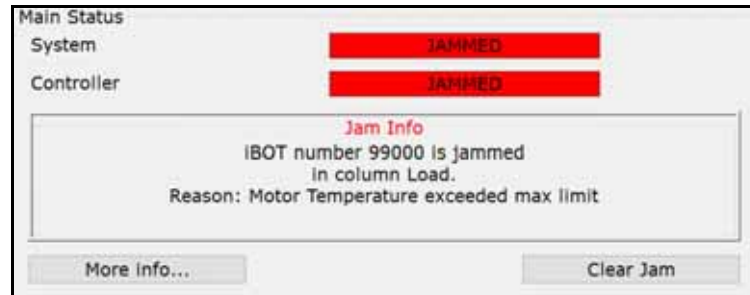

**Figure 4-18: Motor Temperature Exceeded Max. Limit**

#### 4.4.2.5. iBOT Cannot Deliver Items

Sometimes an iBOT cannot deliver an item to a bin. For example, an iBOT may attempt to deliver an item to a bin that, for some reason, is not in place (see Figure 4-19).



**Figure 4-19: Bin Missing**

A sensor on the iBOT detects the presence of the bin before unloading the item, and if the bin is not in place, the Run Screen will alert you to which bin is in need of attention, and the iBOT will wait for action to be taken (see Figure 4-20).



**Figure 4-20: iBOT Waiting for Bin**

The machine will continue to run and the other iBOTs will deliver items.

The iBOT will detect that the bin has been replaced and will deliver the item. You can also click **Cancel Dlvry** and the iBOT will return to the loading column and reject the item.

#### **4.4.2.6. iBOT Failed to Unload Items**

Sometimes an iBOT cannot unload an item. For example, an iBOT may attempt to deliver an item to a bin that already has items in it. While the item is being unloaded, it hits another item in the bin. This causes the item to get stuck (see Figure 4-21).



**Figure 4-21: Item Hits Another Item in the Bin**

At this point, the Run screen will alert you to which bin is in need of attention, and the machine will pause, allowing time for an Authorized Employee to move the item into the bin (see Figure 4-22).

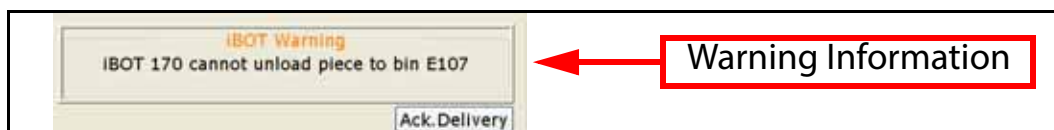

**Figure 4-22: iBOT Failed to Unload Item**



### 4.4.2.7. Overheight Item Detected Warning

An overheight detector is used to uncover items that are too tall for the machine. The system is designed to stop the conveyor if items taller than approximately 4 inches are detected (see Figure 4-23).



**Figure 4-23: Overheight Item Detected Warning**

Only if the item's specified limitations are not exceeded as defined in [Figure 4-29 on page 138](#), the item can be rotated so that it is just a little bit shorter than the 4 inches to resume the run (see Figure 4-24).

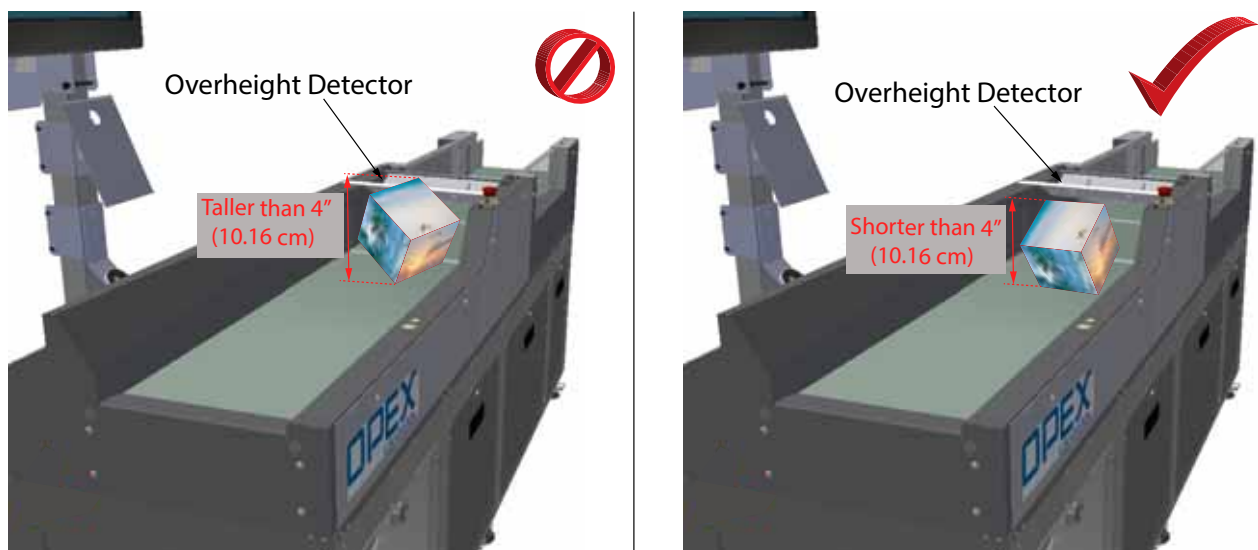

**Figure 4-24: Rotating Item That is Too Tall**

### 4.4.3. Product-Related Jams

Other possible causes of jams are shown in the following figures.

#### **NOTICE**

For all of the product-related jams, you will need to contact an Authorized Employee or OPEX Technician to resolve the issue.

Bulky items in soft plastic packaging can get knocked off the iBOT and fall to the aisle floor (see Figure 4-25). An iBOT will eventually collide with it, causing a jam.

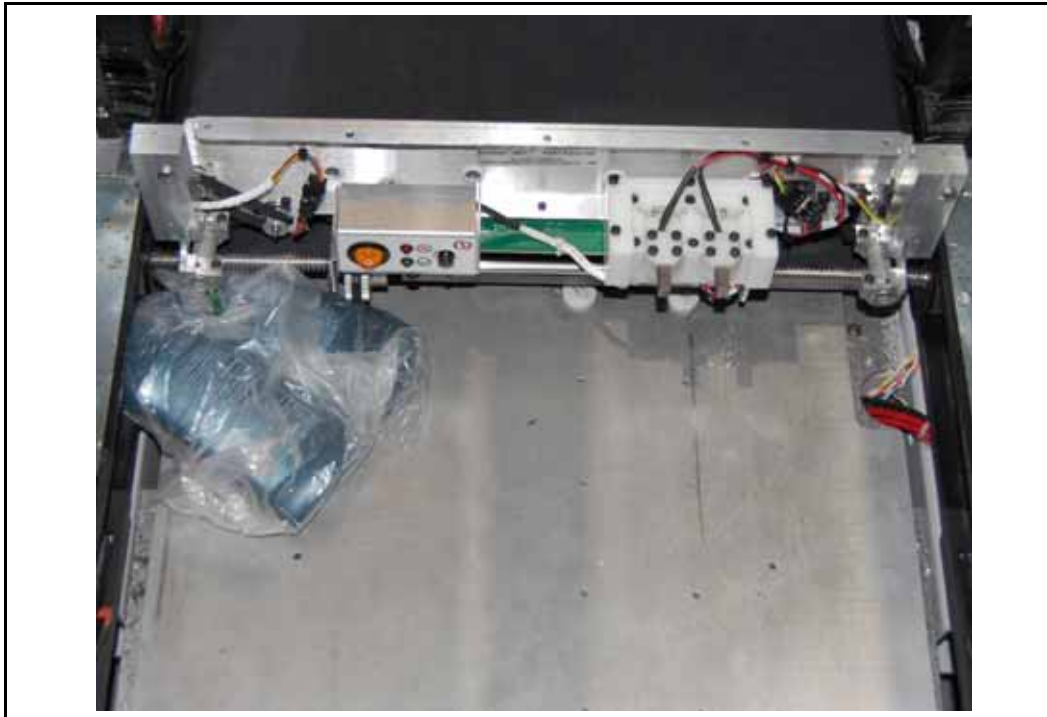

***Figure 4-25: Product Falling into the Machine***

The jam shown below can happen when a round or cylindrical item is placed on the conveyor oriented as shown (see Figure 4-26). The item wants to roll in the opposite direction on the conveyor causing it to lag. When the item triggers the first conveyor sensor, a timer is started. If the item doesn't reach the iBOT before the timer expires, the track is stopped and the load failure jam message appears.

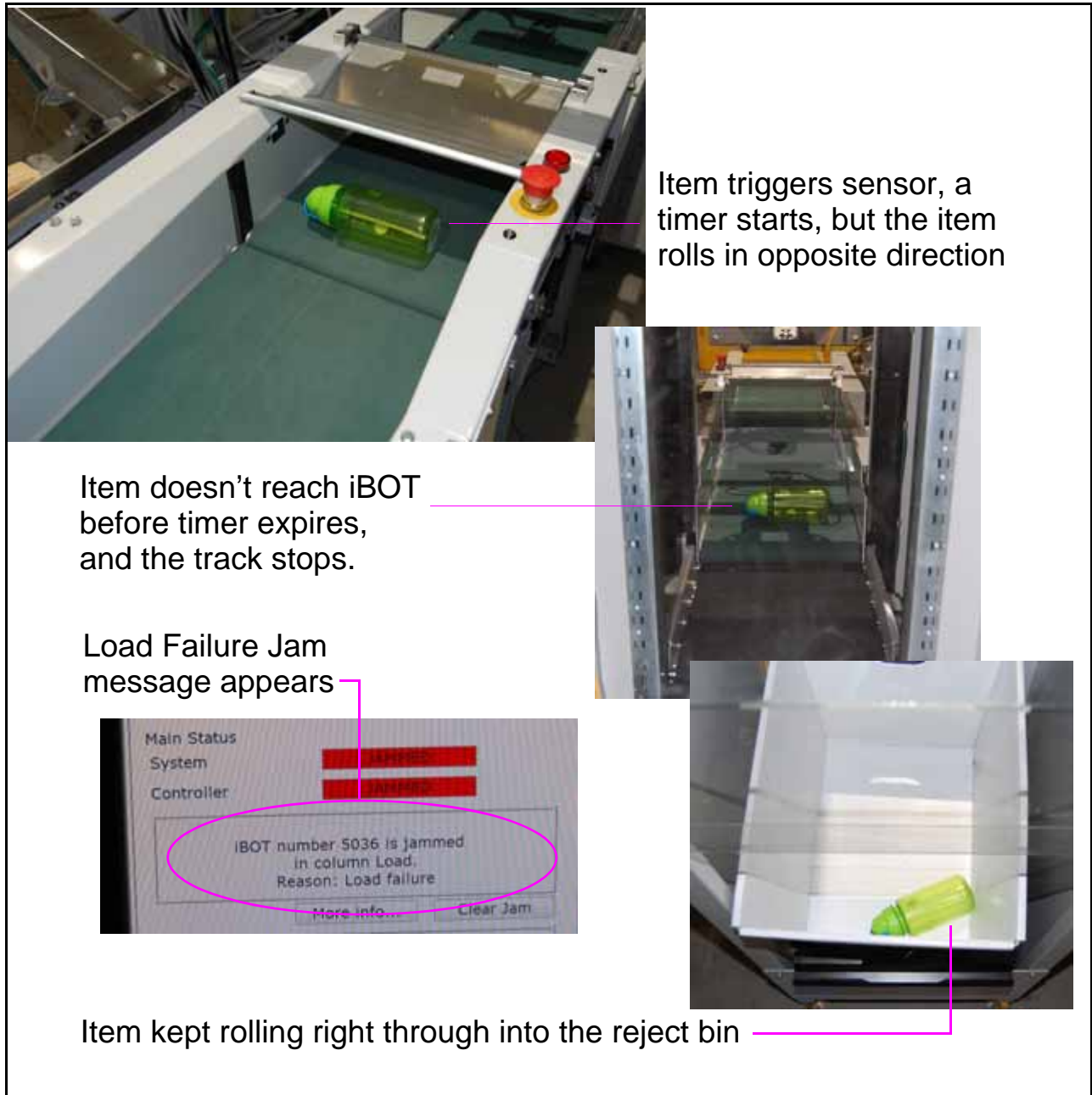

**Figure 4-26: Load Failure Item**

---

---

## 4.5. Starting the Machine & Running a Job

---

---

### 4.5.1. Starting the Machine



#### CAUTION

The moving parts of the Sure Sort™ can become jammed and/or damaged by foreign objects. Make sure the conveyor and iBOT loading areas are clear before you click  in the next step.

#### How to start the machine:

1. On the OPEX Host Run Screen, click  (see Figure 4-27). At this point, the conveyors will start to run, and the iBOTS will cycle, so that they maintain their charge in preparation for delivering items to bins.

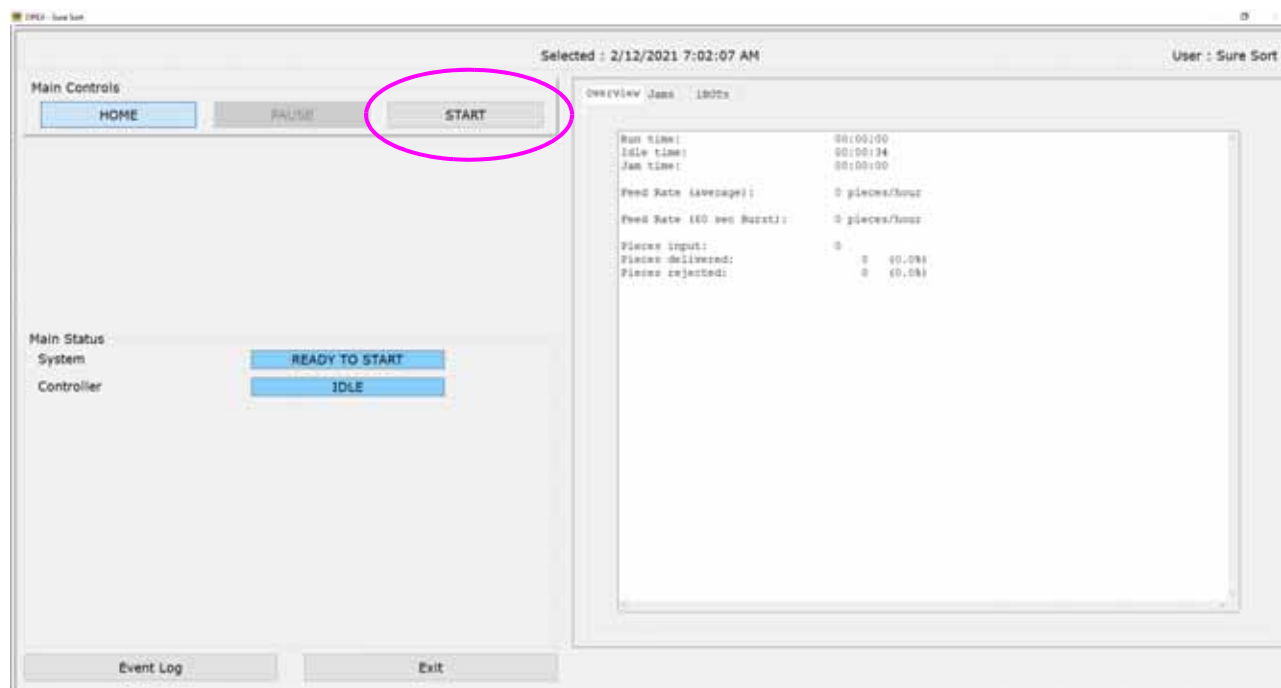

**Figure 4-27: OPEX Host Run Screen**

2. For the duration of the run, you will use the OPEX Induct ELC software to view the process.

- When the system is ready for the first item to be entered, the ELC software interface will display the word "Ready" (see Figure 4-28).

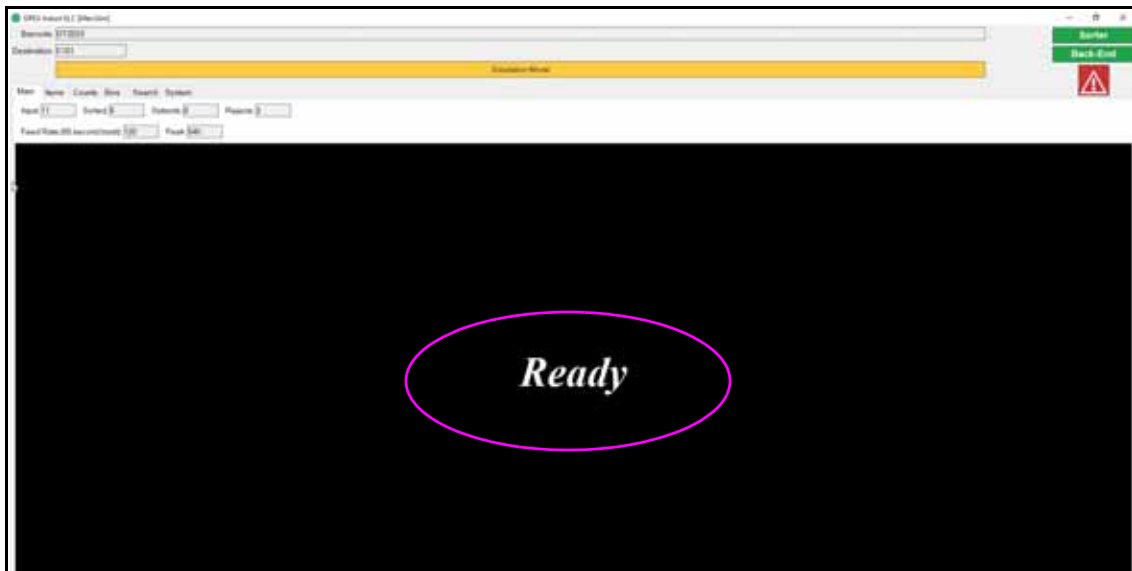

**Figure 4-28: OPEX Induct ELC Screen**

## 4.5.2. Feeding Items into the Machine

**WARNING**

Keep loose clothing, hair, and jewelry away from the conveyor when placing items on the conveyor.

### How to feed items into the machine:

- Ensure the specified limitations are not exceeded (see Figure 4-29).

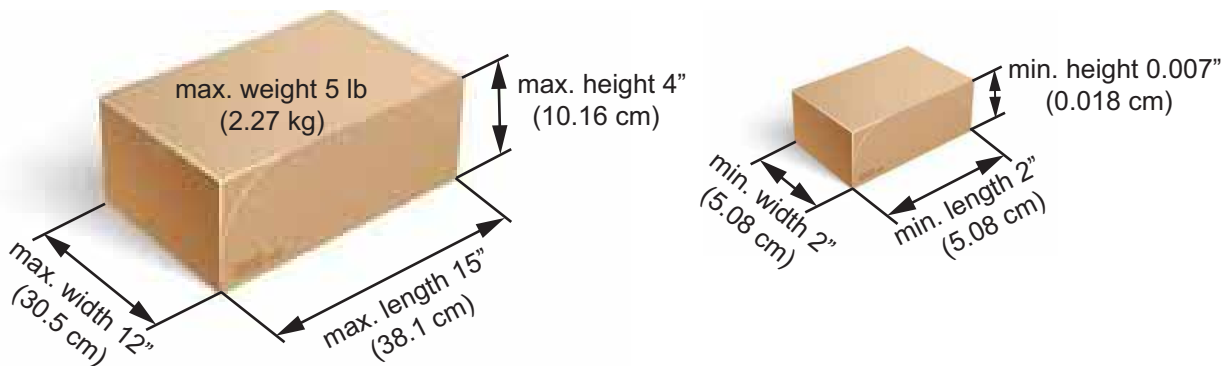

**Figure 4-29: Specification Limits**

2. Place items on the pacing conveyor belt. Avoid overloading the belt. Items should be placed about 3" (8cm) apart from each other (see Figure 4-30).



**Figure 4-30: Conveyor "Drop Zone"**

3. Each item is scanned for a barcode. If the barcode read was successful, "Good Read" will be displayed (see Figure 4-31).

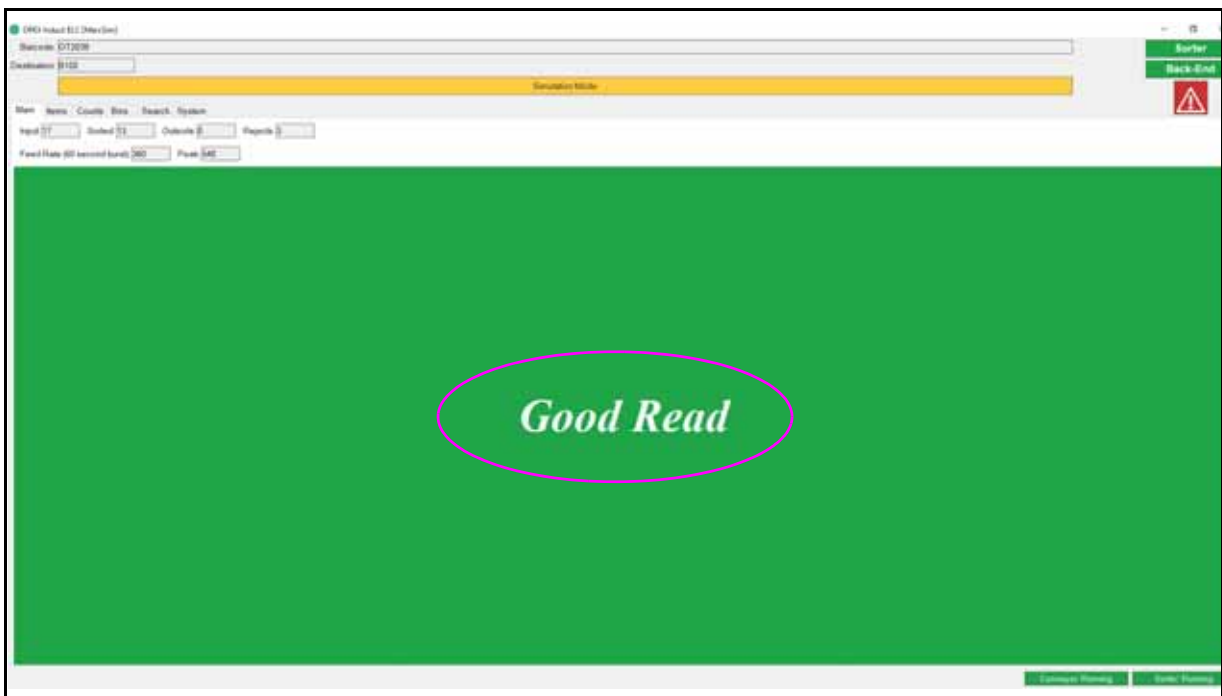

**Figure 4-31: OPEX Induct ELC - Good Read**

- When the item is scanned, the Induct ELC will receive a bin assignment for the piece, and the software notifies the iBOT of the delivery bin destination.

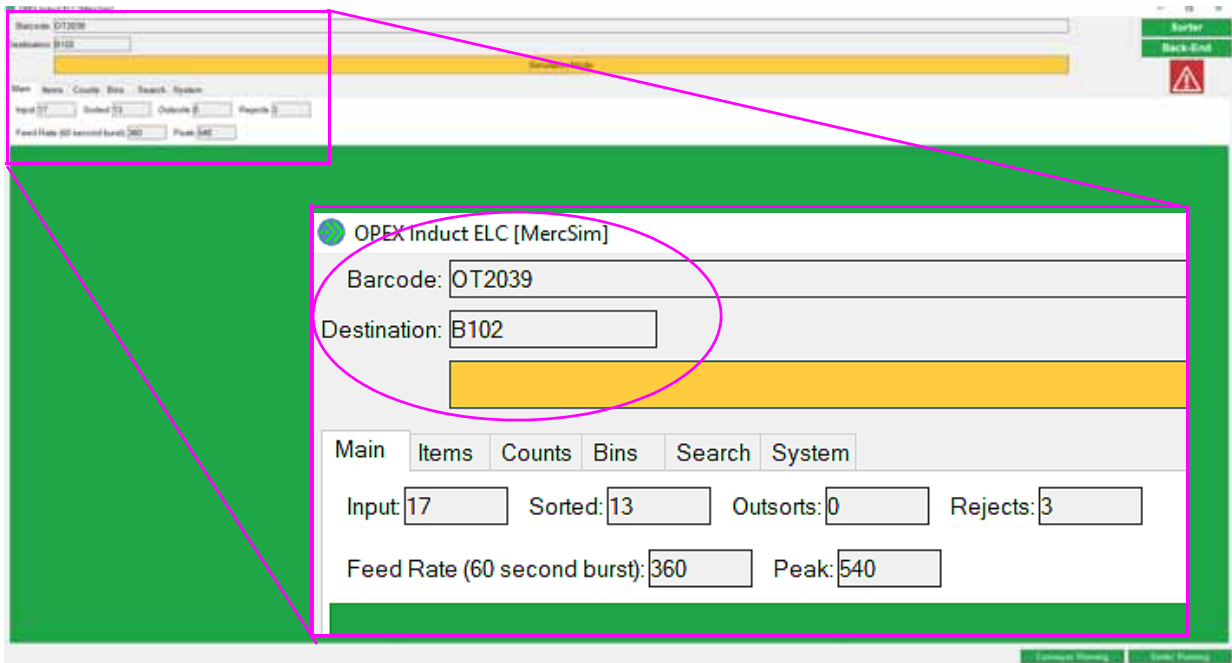

**Figure 4-32: Bin Destination Scanned Item**

- The imaging conveyor belt carries the item to an awaiting iBOT (see Figure 4-33).

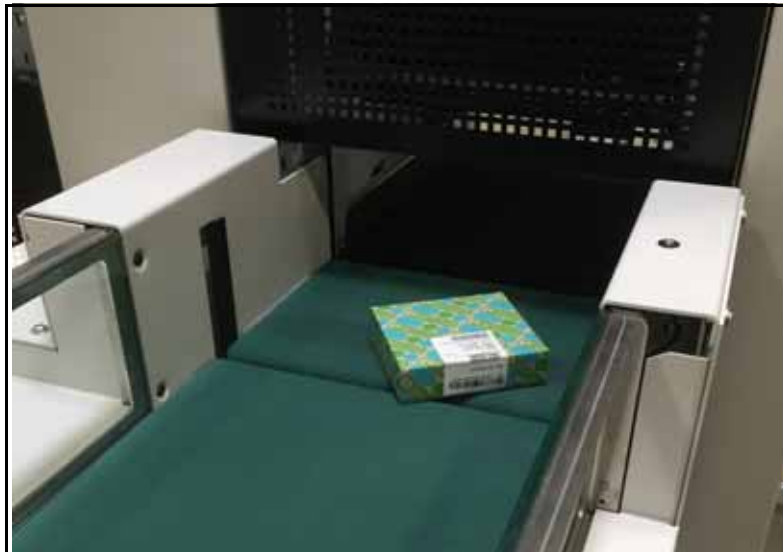

**Figure 4-33: Imaging Conveyor Belt Delivers Item to iBOT**



6. The iBOT carries the item to its destination, releases the item to the bin, and cycles back to the loading column.
7. Place the next item on the pacing conveyor belt, and the process repeats.

**Note:** *You do not have to wait until the iBOT returns to place the next item. You can continue to place items on the belt, assuming there are enough iBOTs to deliver the product.*

If the barcode could not be read, the iBOT will send the item to the designated no-read bin (or the optional return conveyor). The OPEX Induct ELC Screen will display “No Read” (see Figure 4-34). The operator can then use the optional hand scanner, or single scan camera to enter the barcode into the system, and send the item back through the machine (see “Scanning Items Manually” for further details).

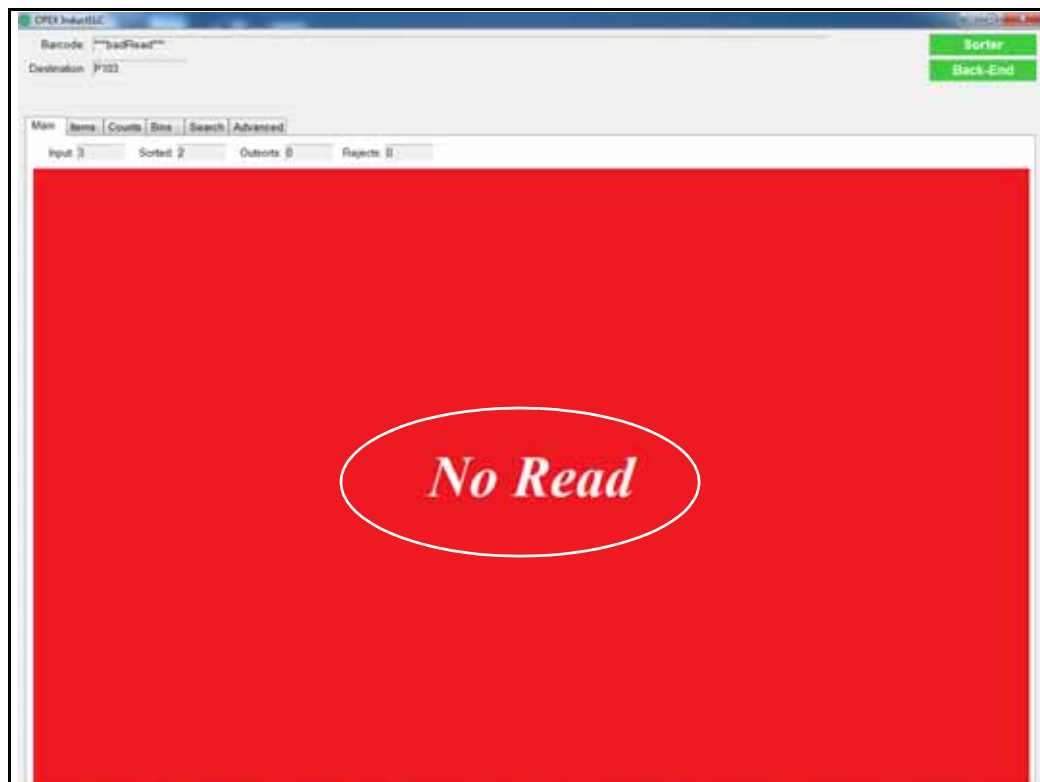

**Figure 4-34: OPEX Induct ELC Screen - No Read**

### 4.5.3. Scanning Items Manually

The optional Single Scan Camera and Hand Scanner allow the operator to scan items manually. Follow the steps below to ensure that a manually scanned barcode is properly paired to the correct item.

#### How to scan items manually:

1. Depending on which scanner you are using, check the Single Scan Camera or the Hand Scanner to ensure the reader light is active.
2. Check the screen of the OPEX Induct ELC. It should be black and display “Ready” (see Figure 4-35).

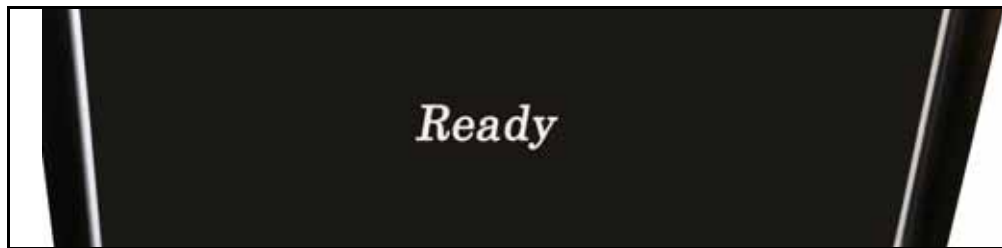

**Figure 4-35: Ready for Scanning an Item**

3. If you are using the Single Scan Camera, hold the item with the barcode facing up directly under the camera (see Figure 4-36). If you are using the Hand Scanner, place the scanner light at the center of the barcode.

**Note:** *If necessary, you may have to move the scanner light up and down the barcode to get a good reading.*

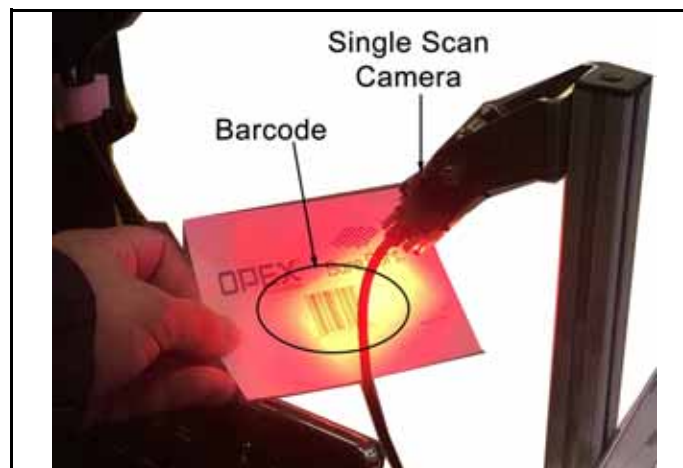

**Figure 4-36: Scanning a Barcode**

4. Check the screen of the OPEX Induct ELC. If the read was successful, it will be green and display “INDUCT” (see Figure 4-37).

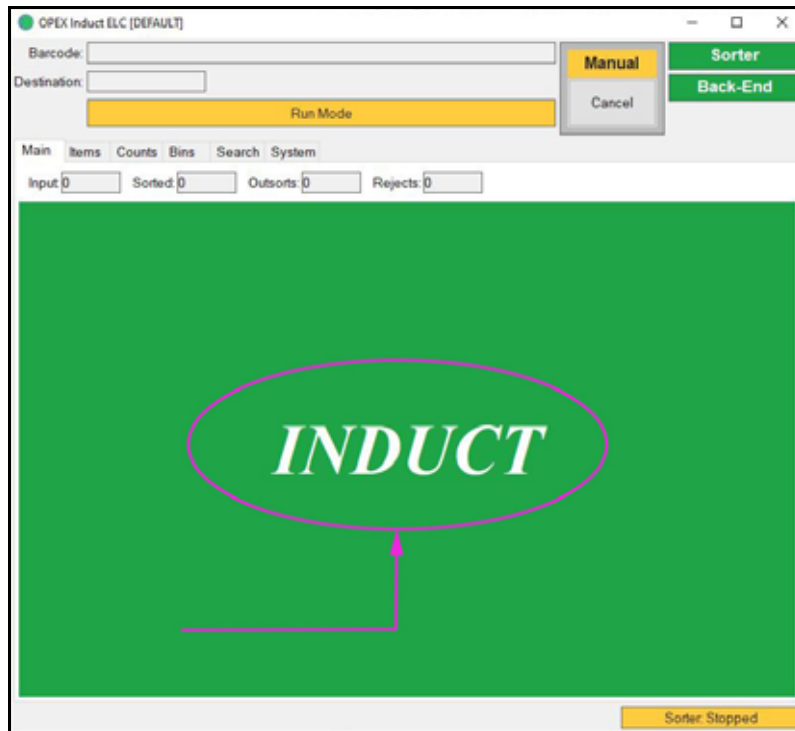

**Figure 4-37: OPEX Induct ELC Screen - Read Successful**

5. Place the item on the conveyor as shown below (see Figure 4-38).

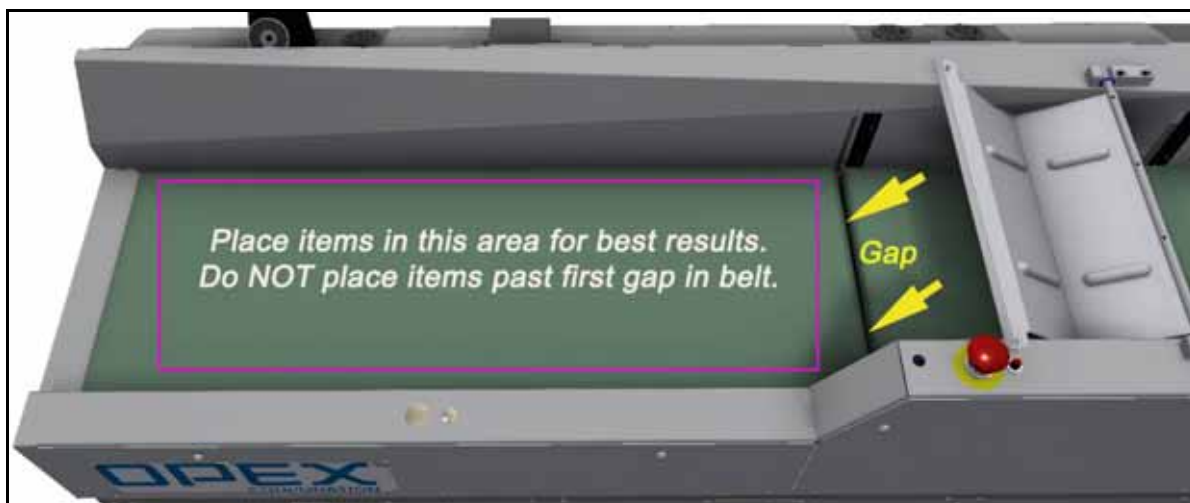

**Figure 4-38: Conveyor “Drop Zone”**

**Note:** Ensure that the item’s specified limitations are not exceeded as defined in [Figure 4-29 on page 138](#)

6. To minimize possible barcode pairing errors, it is good practice to wait until the scanned item is on the iBOT, before scanning a new item (see Figure 4-39).



**Figure 4-39: Scanned Item on iBOT**

### How to cancel a manual scan:

If a barcode was accidentally scanned, you may cancel the manual scan by pressing “Cancel” on the OPEX Induct ELC screen (see Figure 4-40).

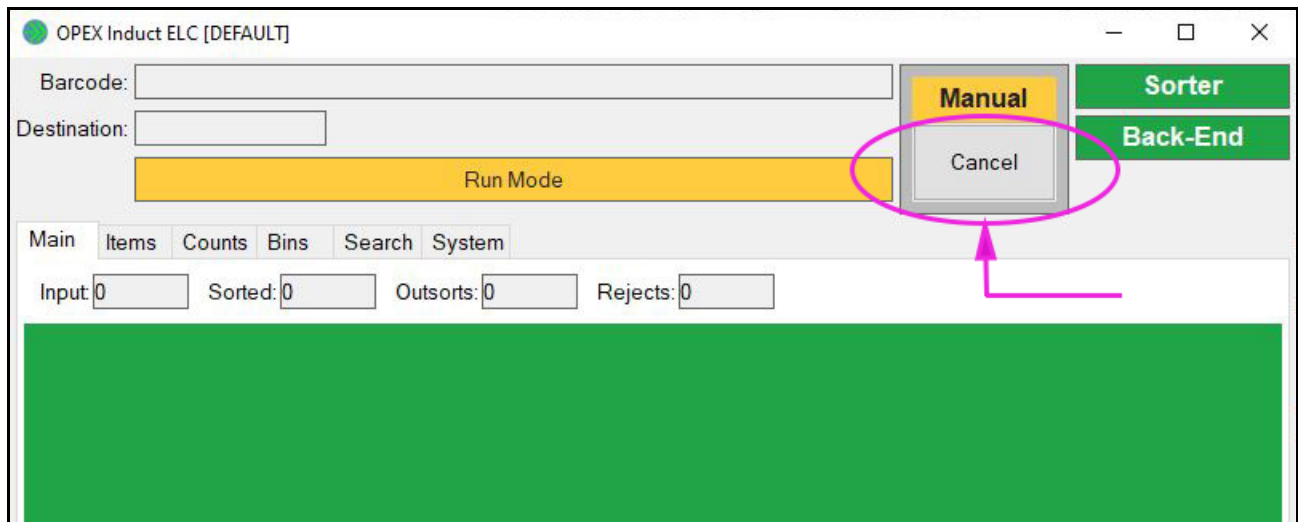

**Figure 4-40: Cancel Manual Scan**

---

---

## 4.6. Stopping the Machine & Exiting the Job

---

---

### How to stop the machine:

1. When finished, on the OPEX Host screen, click **STOP** (see Figure 4-41). This stops the conveyors and homes the iBOTs.

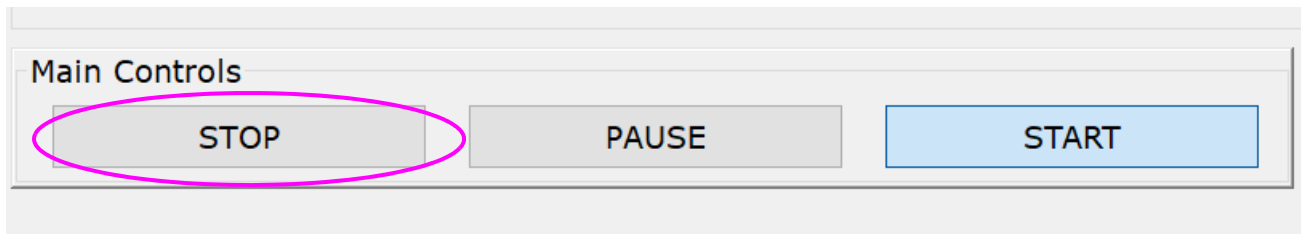

**Figure 4-41: OPEX Host Run Screen - STOP Button**

2. To exit out of the Run Screen, click **Exit** (see Figure 4-42).

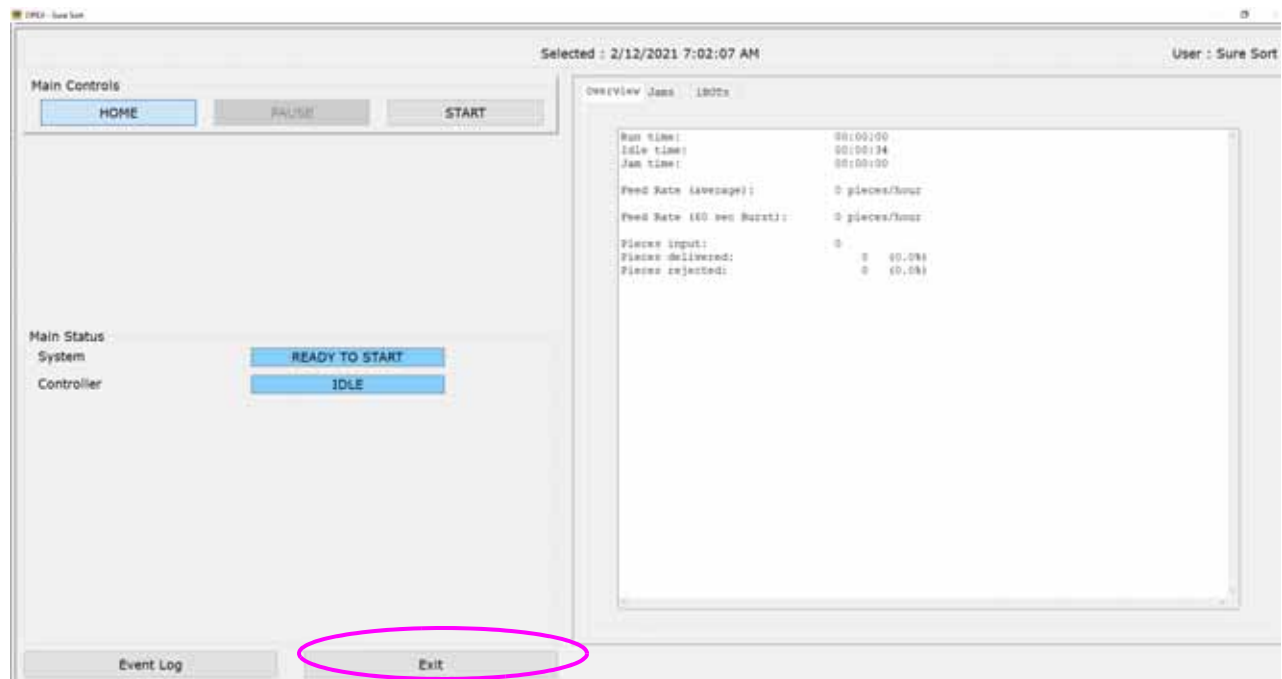

**Figure 4-42: OPEX Host Run Screen - Exit**

3. The Host Software Interface window appears (see Figure 4-43).

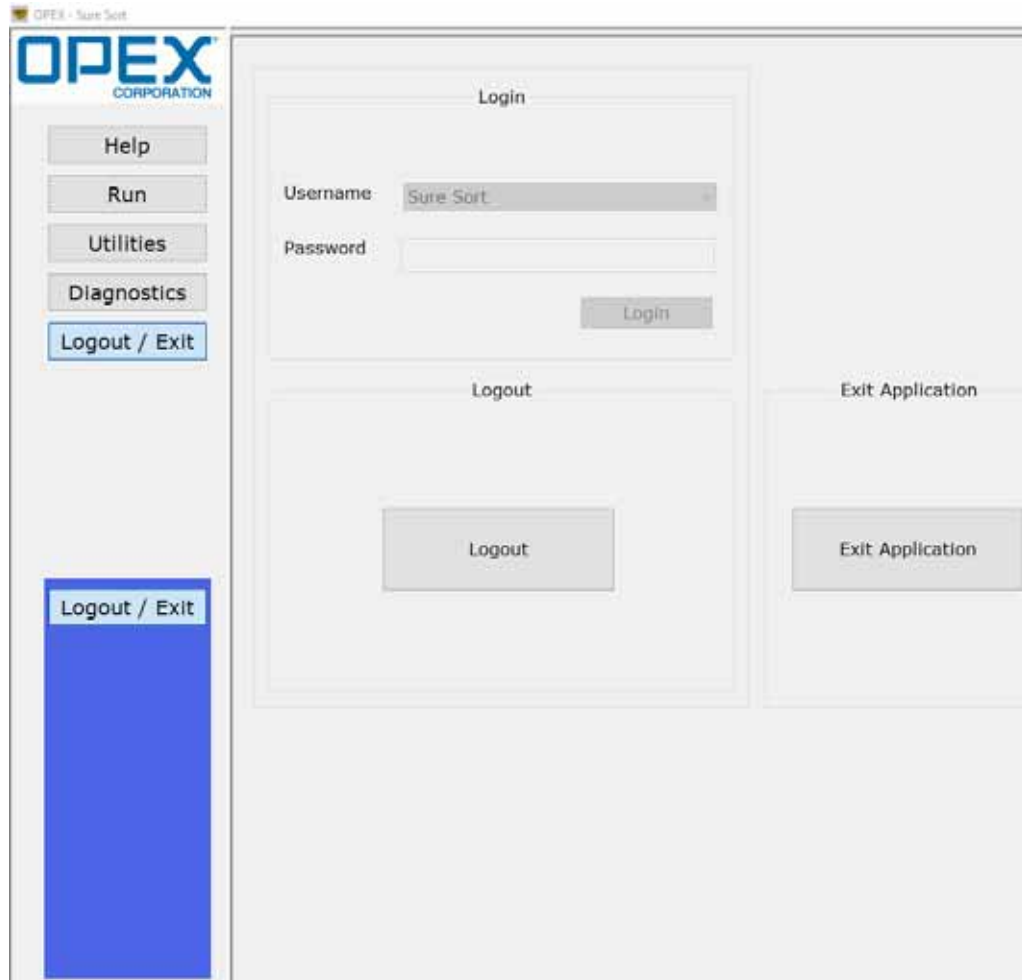

**Figure 4-43: Host Software Interface Window**

# 5. Statistics

<b>5.1. Introduction</b> .....	<b>148</b>
<b>5.2. Creating Reports</b> .....	<b>148</b>
5.2.1. Setting the Time Range .....	149
<b>5.3. Reject and Jam Definitions</b> .....	<b>150</b>
5.3.1. Rejects .....	150
5.3.2. Jams .....	154
5.3.3. Safety-Related jams .....	159



---

---

## 5.1. Introduction

---

---

The Sure Sort™ statistics provide information on the jobs run on the system.

---

---

## 5.2. Creating Reports

---

---

On the Induct ELC screen, click the **Counts** tab (see Figure 5-1).

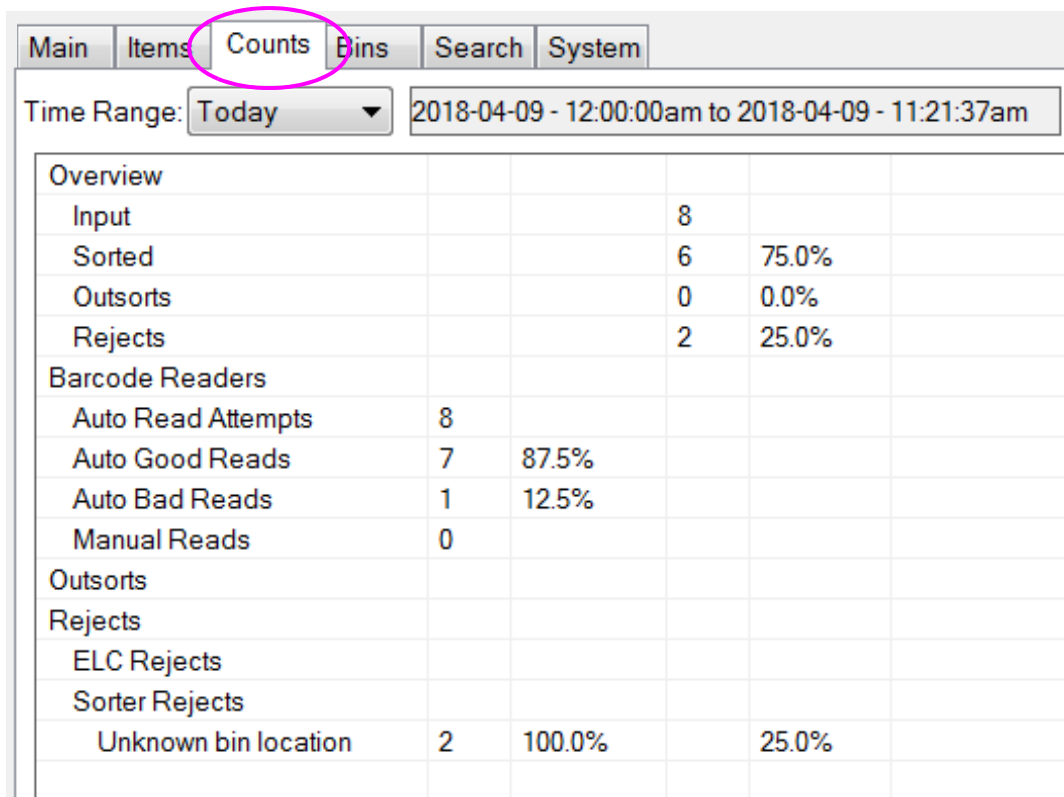

Main   Items   <b>Counts</b>   Bins   Search   System				
Time Range: Today ▼ 2018-04-09 - 12:00:00am to 2018-04-09 - 11:21:37am				
<b>Overview</b>				
Input			8	
Sorted			6	75.0%
Outsorts			0	0.0%
Rejects			2	25.0%
<b>Barcode Readers</b>				
Auto Read Attempts	8			
Auto Good Reads	7	87.5%		
Auto Bad Reads	1	12.5%		
Manual Reads	0			
<b>Outsorts</b>				
<b>Rejects</b>				
ELC Rejects				
Sorter Rejects				
Unknown bin location	2	100.0%		25.0%

**Figure 5-1: Induct ELC Screen - Counts Tab**

The Counts tab will show amounts and percentages of the following fields:

- Overview - this sections shows:
  - **Input** - total number of items run through the system
  - **Sorted** - total number of items successfully sorted
  - **Outsorts** - Customer Backend told item to go to a different location and not to sort
  - **Rejects** - total number of system rejects

- Barcode Readers:
  - **Auto Read Attempts** - total number of barcodes read
  - **Auto Good Reads** - total number of successful barcodes read
  - **Auto Bad Reads** - total number of bad barcode reads
  - **Manual Reads** - total number of manual barcode reads
- Outsorts - Customer Backend told item to go to a different location and not to sort
- Rejects:
  - **ELC Rejects** - Customer backend not ready to send to a bin (most common)
  - **Sorter Rejects** - Host issue - examples: Unknown bin location, Barcode scan time out, Unread piece, Gap to small, iBOT unavailable

## 5.2.1. Setting the Time Range

Selecting a Time Range (see Figure 5-2) you would like to use for your statistics report. Click the down arrow and select from the available options: Current Run, Today, Yesterday, This Week, Last Week.

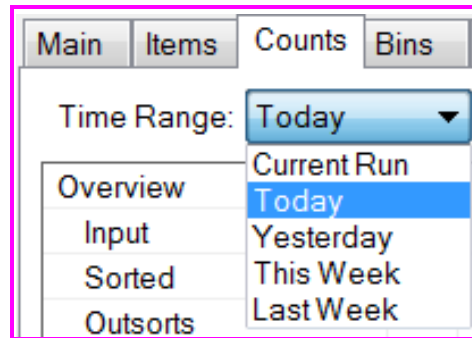

**Figure 5-2: Counts Tab - Time Range**

Click the **Export** button at the bottom of the Counts window to save a .csv file of your current report to the hard drive. The .csv file will be saved to the default directory: C:/OPEX/Export/Induct ELC.

---

---

## 5.3. Reject and Jam Definitions

---

---

### 5.3.1. Rejects

Reject codes are sent to the internal ELC piece database for tracking and to be sent to RPM. These codes are not sent to the WMS back-end.

The .csv file that you export from the ELC screen will only display rejects if they occurred during the selected time range in your report. The following is a list of all possible rejects.

#### 5.3.1.1. ELC Rejects

Reject Message	Description
<b>Barcode Scanner Timeout</b>	When the ELC is expecting a barcode read from the barcode plugin, but does not get it in time.
<b>Multiple Pieces Triggered</b>	When there are pieces too close together and they cross the imaging sensor. The ELC will not be able to accurately pair the barcode to the correct piece so it will reject them both. Overlaps with the Host 'Gap Too Small' reject reason, so will not be triggered too often, but remains as an added assurance.
<b>Unexpected Piece</b>	The ELC expects pieces being inducted to pass through the states in an expected order. When a piece enters states out of order, usually due to a timing issue, the ELC will reject it with this code.
<b>No Read</b>	The ELC received a blank read from the barcode scanner plugin.
<b>Not Found</b>	The barcode received by the ELC was not found in the WMS back-end database, or the back-end returned a blank destination in response to the ELC's barcode request.
<b>Back-End Not Connected</b>	The WMS back-end is not connected to the ELC. Any piece inducted while the back-end is not connected will be rejected for this reason.

<b>Reject Message</b>	<b>Description</b>
<b>Back-End Requested Reject</b>	The WMS back-end has requested the ELC reject the inducted piece.
<b>Back-End Timeout</b>	The WMS back-end did not respond to the ELC's destination request in the allotted time. The ELC will reject the piece since it did not receive its location.
<b>Sorter Reject</b>	This is used for the piece database and between the Host and ELC. In the piece database if you were to look at the piece, the reject reason (if it originated at the Host) would be '9' in the ELC reject column, then whatever the Host reject code was. The ELC uses this to increment its counts for Host rejects (Host rejects and ELC rejects are counted separately).
<b>Invalid Destination Bin</b>	The WMS back-end has given the ELC a destination that is not valid with the configured bin map.
<b>Barcode Not Paired</b>	The barcode sent to the WMS back-end by the ELC was unable to be paired with a piece.
<b>Piece Lost</b>	The piece was lost within the machine. This is most commonly due to the iBOT reaching its destination without a piece on it. Another situation would be if the operator leaves the Host Run screen while there are still undelivered pieces in the machine. Leaving the Run screen closes the connection between the Host and the ELC, so the ELC is no longer able to track the pieces and may not get the Host's 'Abandoned at End of Job' reject reasons.
<b>Waiting for Destination at End of Run</b>	A piece was waiting for a destination when the run was ended. The piece is rejected, and the ELC lists the reject reason as "Waiting for Destination at End of Run."

### 5.3.1.2. Host Rejects

Reject Message	Description
<b>Jamsort</b>	The pieces rejected after a jam condition. The pieces that are past the imaging sensor when the system restarts after a jam will be rejected for this reason.
<b>Length Too Long</b>	The piece being inducted was over the maximum allowable length. It would be too long for the iBOT.
<b>Gap Too Small</b>	The pieces being inducted are too close together when passing the imaging sensor. The Controller will not be able to stop the conveyor to separate them onto two different iBOTs and rejects them.
<b>No iBOTs Available</b>	There are no iBOTs available to take the piece being inducted. This happens when there are not enough iBOTs in the system. The iBOT at the load point will have a piece on it and no iBOT below it. If another piece passes the image sensor, the piece on the iBOT will be sent to the reject bin with this reason to prevent multiple items from being loaded onto the same iBOT. The iBOT will not be able to leave the load position unless another iBOT has taken a position below it.
<b>Host to Controller Response Missing</b>	The Host is unable to communicate with the Real-Time Controller. The Controller is the software that maintains the positions of all iBOTs in the machine. Since the Host cannot communicate, the piece is rejected.
<b>Unknown Bin Location</b>	The piece was given a destination bin that is not valid in the configured bin map.
<b>Unknown Reason</b>	The Host has rejected the piece but has not assigned a reject reason.

<b>Reject Message</b>	<b>Description</b>
<b>Abandoned at End of Job</b>	The operator quit a job (left the Run screen by pressing 'End Job') while the machine was in a jammed state and there were undelivered pieces still in the machine. When the system is restarted, the undelivered items will be sent to the reject bin with this reject reason as leaving the Run screen wipes the destination locations from the associated pieces.
<b>ELC Requested Reject</b>	This is used for the piece database and between the Host and ELC. In the piece database if you were to look at the piece, the reject reason (if it originated at the ELC) would be '24' in the Host reject column, then whatever the ELC reject code was. The Host uses this to increment its counts for ELC rejects (Host rejects and ELC rejects are counted separately).
<b>ELC Timeout</b>	The Host did not receive destination data from the ELC in the allotted time frame.
<b>ELC Insufficient Return Data</b>	The ELC did not provide the Host expected data to determine the destination for the inducted piece. This should never occur.
<b>Invalid Destination</b>	This code will only be used for the Sure Sort XL machine. The destination assigned to the piece is not a valid location in the configured bin map.
<b>Item Flushed</b>	This code will only be used for the Sure Sort XL machine. If input conveyor restarts with pieces beyond the tracking point, the items are flushed and rejected.
<b>Failed to Unload at Return Conveyor</b>	This code will only be used for the Sure Sort XL machine. The iBOT was unable to unload the piece onto the return conveyor. The piece will then be sent to the reject bin.

## 5.3.2. Jams

The .csv file will only display jams that occurred during the selected time range in your report. The following is a list of all possible jams.

Jam Message	Description
<b>Charging rail sensor(s) blocked</b>	Each charging rail in the machine (except the one on the main door) has sensors behind it to detect if the rail is extended or retracted. The Real-Time Controller calls a jam if the extended sensor or retracted sensor is blocked when it should not be. The extended sensor will be blocked when the machine is in an idle or stopped state and the iBOTs are parked. It will be in a retracted state when the machine is running and the iBOTs are moving through the column.
<b>Critically low iBOT power</b>	Occurs when the Real-Time Controller detects that the power level of an iBOT is too low to deliver the piece, as it does not have enough power to spin the conveyor and then return to the charge rail.
<b>Critical Message Failure</b>	Occurs when the Real-Time Controller has not received confirmation that the iBOT has received a critical message. This occurs when the iBOT is approaching the loading point.
<b>ELC Communication Error</b>	caused when the Host application loses communication with the External Link Component (ELC).  Loss of communication with the ELC can result in one or more critical messages being lost by the Host application or the ELC, and they may now have conflicting data about pieces in the system. Therefore, the job is not allowed to proceed even if communication can be reestablished with the ELC. The correct disposition of pieces that are in the system, but not yet delivered, needs to be determined.



<b>Jam Message</b>	<b>Description</b>
<b>ELC Requested Jam</b>	Caused when the External Link Component (ELC) connected with the Host application experiences a severe error that it cannot recover from, cannot continue running in that state, and requests the machine to jam.
<b>Pacing Sensor Blocked or Imager Entry Sensor Blocked</b>	Occurs if either of these sensors are blocked when starting a run, or remain blocked for an extended period of time.
<b>Front Safety Controller not Reset</b>	The system has a safety interlock that will not allow the system to run if the reset button attached to the front access door is not pressed. The reset button must be pressed each time the door is opened from a safe state. The reset button will not be active until the door is closed and no other faults have been detected by the safety system.
<b>Host - Controller Communication Failure</b>	Occurs when the communications between the Host application and the Real-Time Controller have stopped.
<b>iBOT Below Minimum Charge</b>	Occurs when the iBOT does not have the recommended minimum charge to leave the charge rail. The iBOT's power level is checked when leaving the charging rail. If it is determined that the iBOT's charge is below the minimum threshold for a defined period, a jam is called.
<b>iBOT Jammed or iBOT Collision Jam</b>	Signaled when something appears to be obstructing an iBOT's path. The difference between a collision jam and a stall jam is that a collision jam is called when an iBOT has detected a sudden unexpected drop in speed, while a stall jam is called when an iBOT does not travel an expected minimum distance over a period of time.

<b>Jam Message</b>	<b>Description</b>
<b>iBOT Conveyor Stall</b>	Occurs when an iBOT cannot detect any movement in its conveyor, if the conveyor is being prevented from moving at its desired speed, or if the conveyor is spinning without having a loaded product.
<b>iBOT Missed Index</b>	There is an index mark located in the loading column, just below the loading position, as indicated by the arrow in the picture. iBOTs recognize this mark and use it to synchronize their position every time they go through the loading column. If an iBOT goes past the position where it expects to see the index mark, but does not see it, it signals this jam.
<b>iBOT Not Above Index</b>	Occurs when an iBOT has either not passed above the index mark or the Real-Time Controller has not received confirmation that the iBOT has passed above the index mark in the expected time.
<b>iBOT Out of Control Detected</b>	Occurs when an iBOT has reached the out of control speed limit despite attempting to control it. In these cases, the iBOT's parking brake is utilized to control the speed.
<b>iBOT Over-Voltage Detected</b>	Occurs when an iBOT detects that it has charged up to a voltage that exceeds its maximum limit.
<b>iBOT Reset Detected</b>	Occurs when the Real-Time Controller detects that an iBOT has reset itself. This can be due to an unexpected power cycling of the iBOT.
<b>iBOT Stall Jam</b>	Occurs when an iBOT does not move the expected minimum distance over a set period of time. This can be due to something impeding the iBOT's forward progress, something caught in the iBOT's axle, an overweight item being placed onto the iBOT, or something dragging on the back of the iBOT.

<b>Jam Message</b>	<b>Description</b>
<b>Inactivity Stoppage</b>	The machine can be configured to stop automatically after a period of inactivity. An Inactivity Stoppage is initiated by the External Link Component (ELC). If stopping after a period of inactivity is not desired, or a different period of inactivity before the stop is desired, the option can be changed or disabled in the ELC settings under the Sorter heading using the option for Inactivity Timeout.
<b>Incompatible iBOTs Detected</b>	The Real-Time Controller has detected an iBOT in the system that is incompatible with the Controller. This can happen if the Controller software is upgraded, but the iBOTs are not, when an iBOT upgrade is necessary. If the software version is below the Controller set minimum, this error will occur, and the iBOT will need to be removed to be upgraded manually.
<b>Input Section E-Stop Pressed</b>	Occurs if the Emergency Stop (E-Stop) switch in the input section (indicated in the picture) has been pressed. E-Stop switches enable a quick stop of all motors in the machine in the event of an emergency involving potential personnel injury.
<b>Load Failure Jam</b>	Occurs when a piece is not loaded properly onto an iBOT at the loading position.
<b>Mechanical Over-height Sensor Blocked</b>	The Mechanical Over-height sensor is located on the input section of the machine, and detects whether a piece going down the conveyor exceeds the maximum height limit of the system. If the mechanical lock is broken upon startup of the system, a jam will be triggered.
<b>No iBOTs Detected</b>	Occurs when the Real-Time Controller cannot detect any iBOTs in the system.

<b>Jam Message</b>	<b>Description</b>
<b>Optical Over-height Sensor Blocked</b>	The Optical Over-height sensor is located on the input section of the machine, and detects whether a piece going down the conveyor exceeds the maximum height limit of the system. If the sensor is blocked upon startup of the system, a jam will be triggered.
<b>Rear Safety Controller not Reset</b>	The system has a safety interlock that will not allow the system to run if the reset button attached to the rear access door of the system is not pressed. The reset button must be pressed each time the door is opened from a safe state. The reset button will not be active until the door is closed.
<b>Return Conveyor E-Stop Pressed</b>	Occurs if the Emergency Stop (E-Stop) switch on the motorized return conveyor has been pressed.
<b>Safety Controller not Ready</b>	The system has a safety interlock that will not allow the system to run if the controller is not in a ready state. All safety features, including emergency stops and door interlocks, must be reset in order to run the system.
<b>Software Error or Software Problems Detected</b>	Occurs when an unexpected situation arises in the software.
<b>Stacker Door is Open</b>	The system has a safety interlock that will not allow the system to run if either of the access doors of the system are open. The door does not have to be completely open in order for this stoppage to occur. If the interlock is broken, even briefly, the system will stop and require a reset once all interlocks have been satisfied.
<b>Stacker Rear Door is Open</b>	The system has a safety interlock that will not allow the system to run if the access door at the rear end of the system is open.
<b>Stacker Section 100-Side E-Stop Pressed</b>	Occurs if one of the Emergency Stop (E-Stop) switches on the 100 side of the machine have been pressed.

<b>Jam Message</b>	<b>Description</b>
<b>Stacker Section 200-Side E-Stop Pressed</b>	Occurs if one of the Emergency Stop (E-Stop) switches on the 200 side of the machine have been pressed.
<b>Unexpected Delivery</b>	Occurs when a piece is delivered to a bin without going through all the checks and processes that it is supposed to go through before delivery. This may be that the proper sensors on the iBOT were not tripped, or that the iBOT did not deliver the correct message to the Real-Time Controller.
<b>Unknown Jam or Unknown Reason Jam</b>	An Unknown Reason jam occurs if the Real-Time Controller signals a jam that the Host is not familiar with. This could occur, for example, if the Controller software has been upgraded, but the Host software has not.
<b>Unload Sensor Blocked Jam</b>	Occurs when an iBOT is at the destination bin of the piece it is carrying, but is unable to deliver it into the bin.
<b>Wireless COM Failure</b>	A wireless com failure will occur when the controller is unable to communicate with one or more iBOTs at the start, restart, or during of a run.

### 5.3.3. Safety-Related jams

<b>Jam Message</b>	<b>Description</b>
<b>Guardian Activated</b>	Occur when an unexpected situation happens in the iBOT's Guardian module. This is a level 1 jam and will only be cleared when a valid reset is done.
<b>Guardian Analog out of Range</b>	This jam indicates that one of the processors on the safety module has detected an invalid voltage on the other processor. This is a level 2 jam.
<b>Guardian Brake Control Failure</b>	This jam indicates that a fault has been detected by the monitor of the brake control circuit. This is a level 2 jam.

<b>Jam Message</b>	<b>Description</b>
<b>Guardian Brake Current Failure</b>	This jam indicates that a fault has been detected by the monitor of the brake current. This is a level 2 jam.
<b>Guardian Chip to Chip Timeout</b>	Indicates that one of the processors on the safety module has stopped seeing the heartbeat line from the other processor. This is a level 2 jam.
<b>Guardian Communication Timeout</b>	Occurs when the main safety controller has not received a response from the iBOT's safety module. Also referred to as a "Black Channel Timeout." This is a level 2 jam.
<b>Guardian Encoder Cross Check</b>	Indicates that an inconsistency has been detected between the encoders in the two safety module processors. This is a level 2 jam.
<b>Guardian Invalid Configuration</b>	Indicates that the loaded configuration is invalid or missing. This is a level 1 jam. This error will only be cleared when a valid configuration is loaded.
<b>Guardian Invalid Reset</b>	Indicates that either one or both of the processors on the safety module have detected an invalid reset either on themselves or on the other processor. This is a level 1 jam. This will only be cleared when a valid reset is done.
<b>Guardian MCLR Seen</b>	Indicates that the one of the safety processors saw the Master Clear/Reset (MCLR) line for the other processor. The MCLR lines are tied to reset buttons and external watchdog chips. The external watchdog chips use timers that require activity between certain time frames. If activity is not seen between the time frames, the chip causes a reset. The chip also contains a voltage monitor that will call a reset if the voltage drops too low. This is a level 2 jam.
<b>Guardian Over-Speed Detected</b>	Indicates that an over-speed condition was detected. This is a level 2 jam.
<b>Guardian Relay Feedback Error</b>	Indicates that one of the processors on the safety module has detected a relay feedback error. This is a level 1 jam.

<b>Jam Message</b>	<b>Description</b>
<b>Guardian Shared Memory Failure</b>	Indicates that one of the processors on the safety module has detected a shared memory error. The shared memory is a section of memory that is continually passed between the two processors on the safety module. When the system is started, the processors go through an initial synchronization to ensure they will be going through resets at the same time. After the synchronization, the shared memory is begun. The shared memory uses a cyclical redundancy check (CRC) to verify that the memory remains synchronized throughout operation. If either the initial synchronization fails, or the CRC fails, this error will be called. Be aware that this may also coincide with an invalid reset error. This is a level 2 jam.
<b>Guardian Software Error</b>	Indicates that one of the processors on the safety module has detected a software error. This is a level 1 jam and cannot be cleared.
<b>Guardian Stop Failure</b>	Indicates that a stop was attempted, but was unsuccessful triggering a stop failure. This is a level 1 jam.
<b>Guardian Test Error</b>	Indicates that one of the processors on the safety module has called a test error. This is only generated from the debug menu while bench testing the safety module. This should never be seen while running in a live system. This is a level 2 jam.



(This page is intentionally blank)

# A. Optional Right-Side (200-Side) Induction

A.1. Introduction .....	164
A.2. E-Stop and Reset Button Locations.....	165
A.3. Equipment Layout and Required Floor Space .....	166
A.4. Right-Side Input Module .....	167

**Sure Sort™**

**Operator Manual for Version 4.2 Machines**

## A.1. Introduction

The OPEX Sure Sort™ offers an optional right-side induction to design more efficient facility layouts. This section describes the key-differences only. Please refer to the prior chapters to view detailed information about operating the machine, safety guidelines, and all other safety-related measures. You can click on the [link](#) next to each component to view information about it (see Figure A-1).

### NOTICE

This available mirror-inverted option does not affect the functionality of the components or operational procedures of the machine.

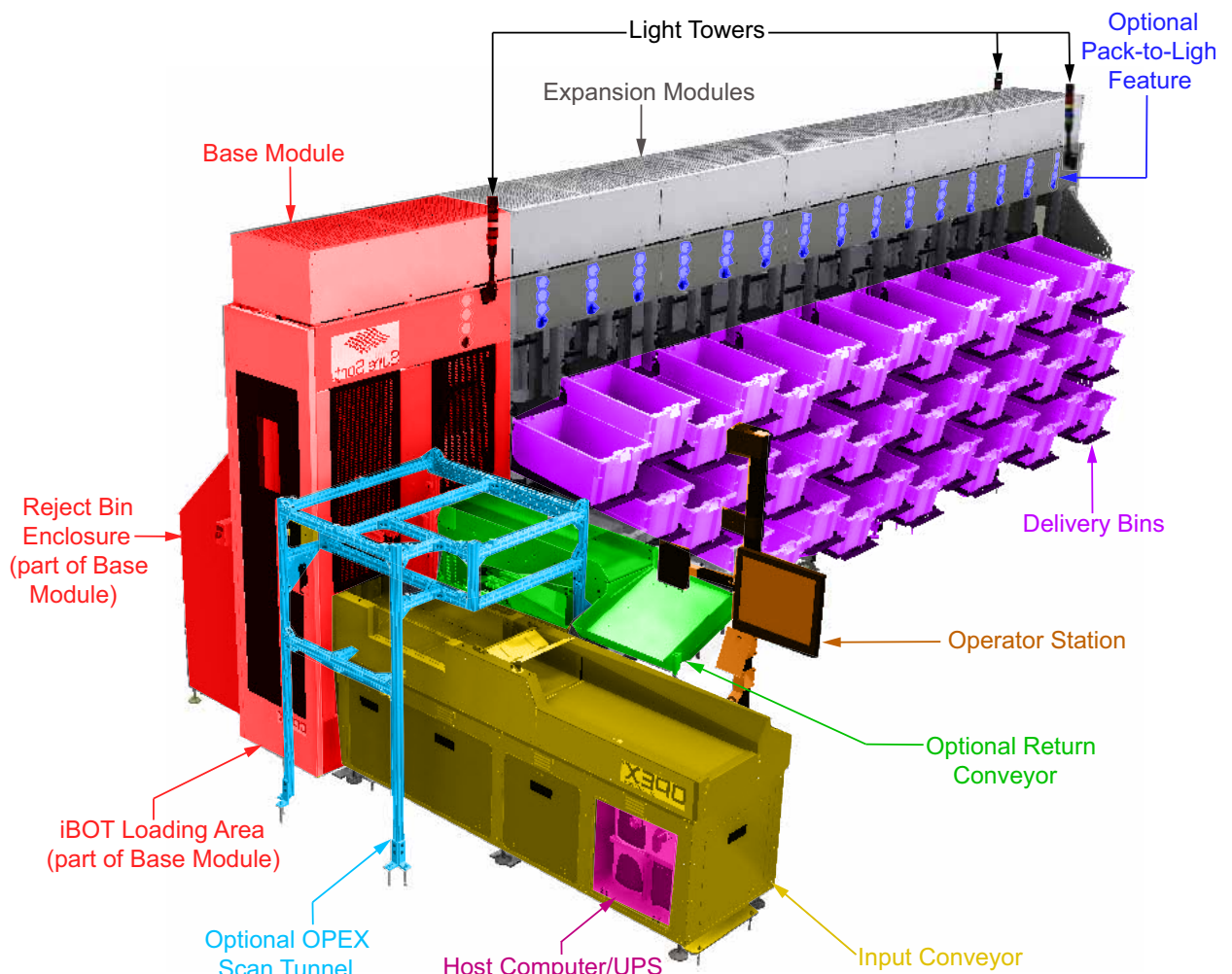

**Figure A-1: Sure Sort - Main Components**

---

---

## A.2. E-Stop and Reset Button Locations

---

---

The locations of the red Emergency-Stop and blue Reset Buttons on machines with the optional right-side induction are illustrated below (see Figure A-2).

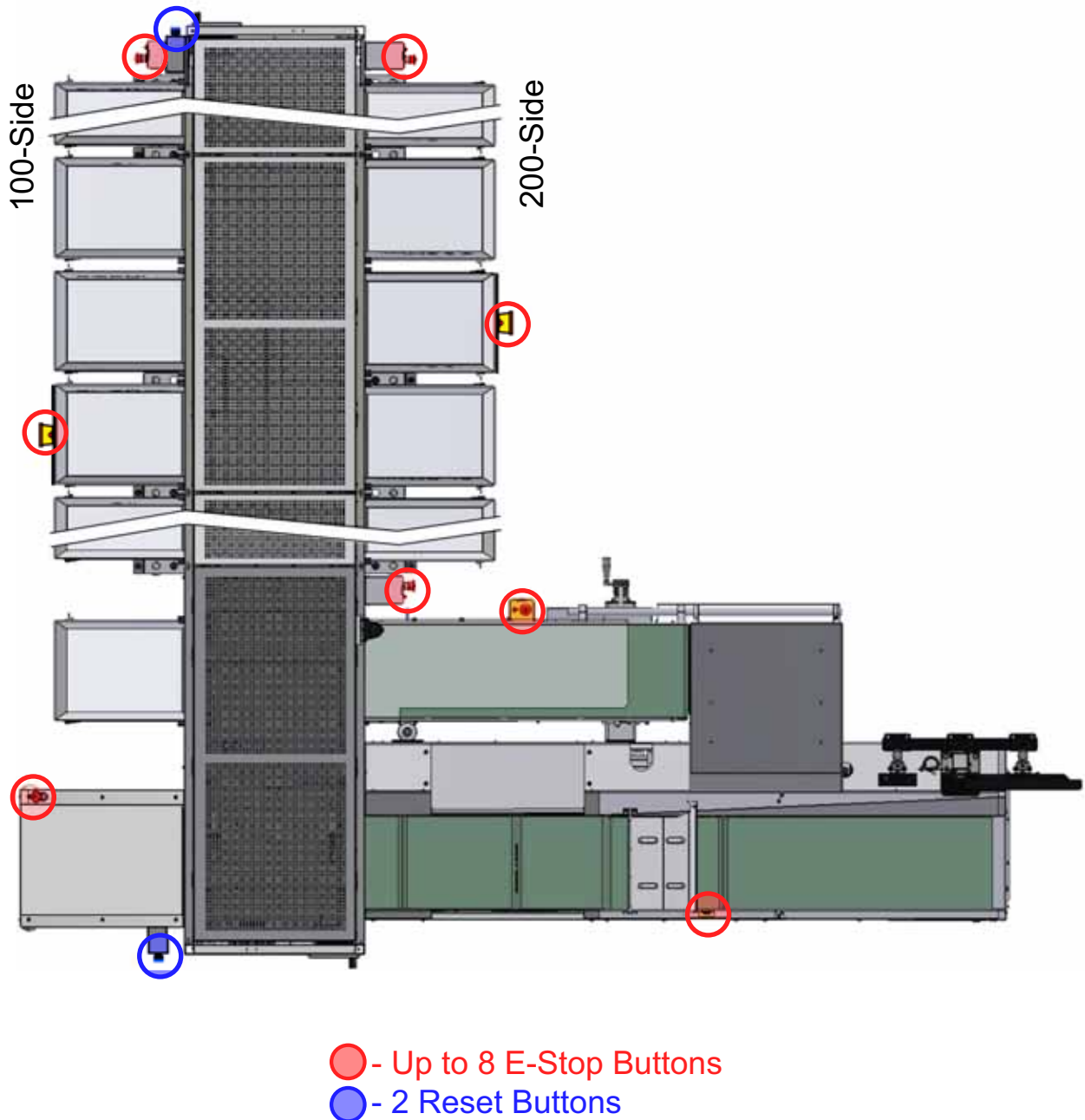

**Figure A-2: E-Stop & Reset Button Locations**

## A.3. Equipment Layout and Required Floor Space

The System Footprint below shows the required floor space for machines with the optional right-side induction (see Figure A-3).

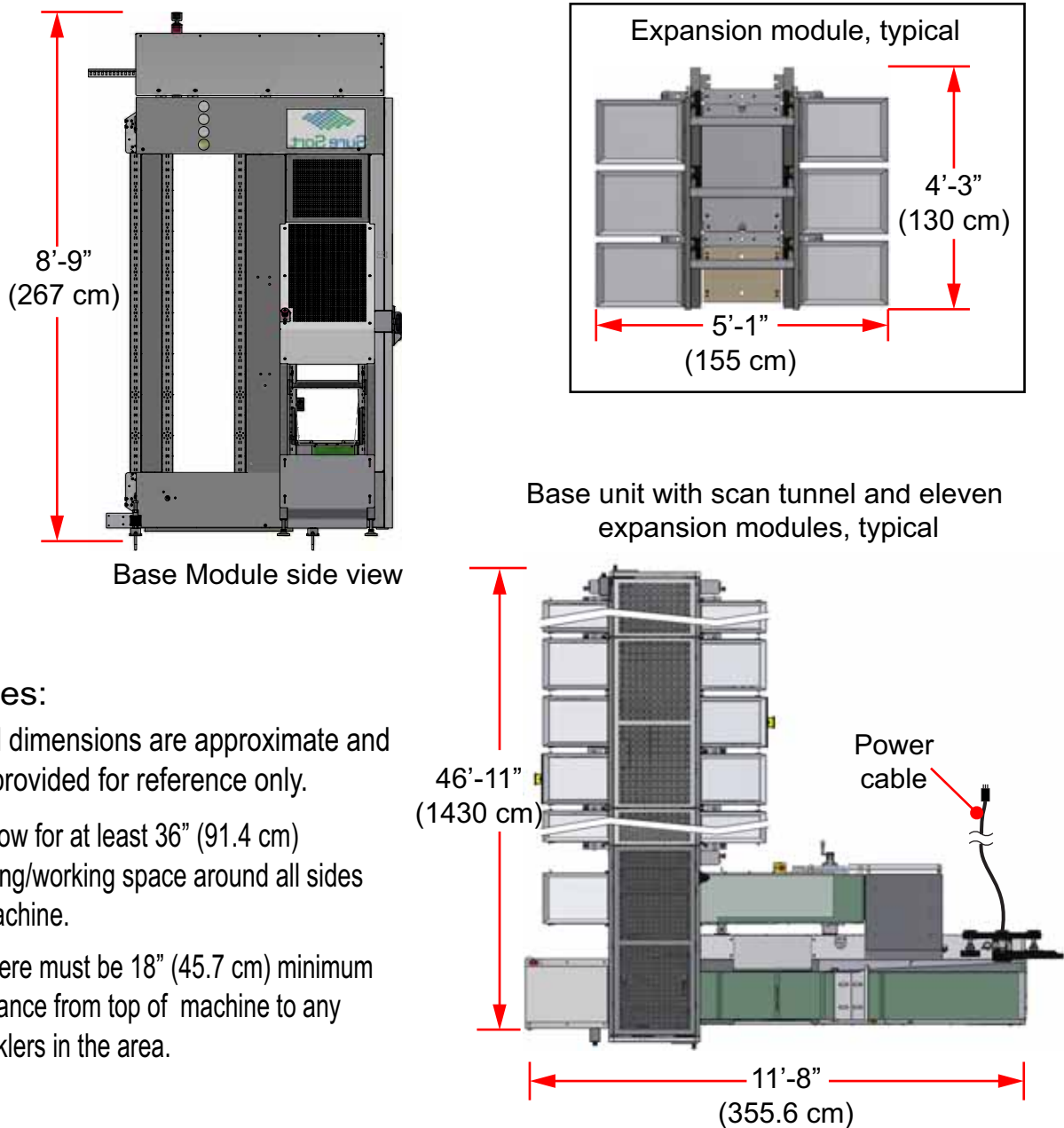

### Notes:

1. All dimensions are approximate and are provided for reference only.
2. Allow for at least 36" (91.4 cm) walking/working space around all sides of machine.
3. There must be 18" (45.7 cm) minimum clearance from top of machine to any sprinklers in the area.

**Figure A-3: System Footprint - Right-Side Induction**

## A.4. Right-Side Input Module

The key components of the right-side input module are illustrated below (see Figure A-4).

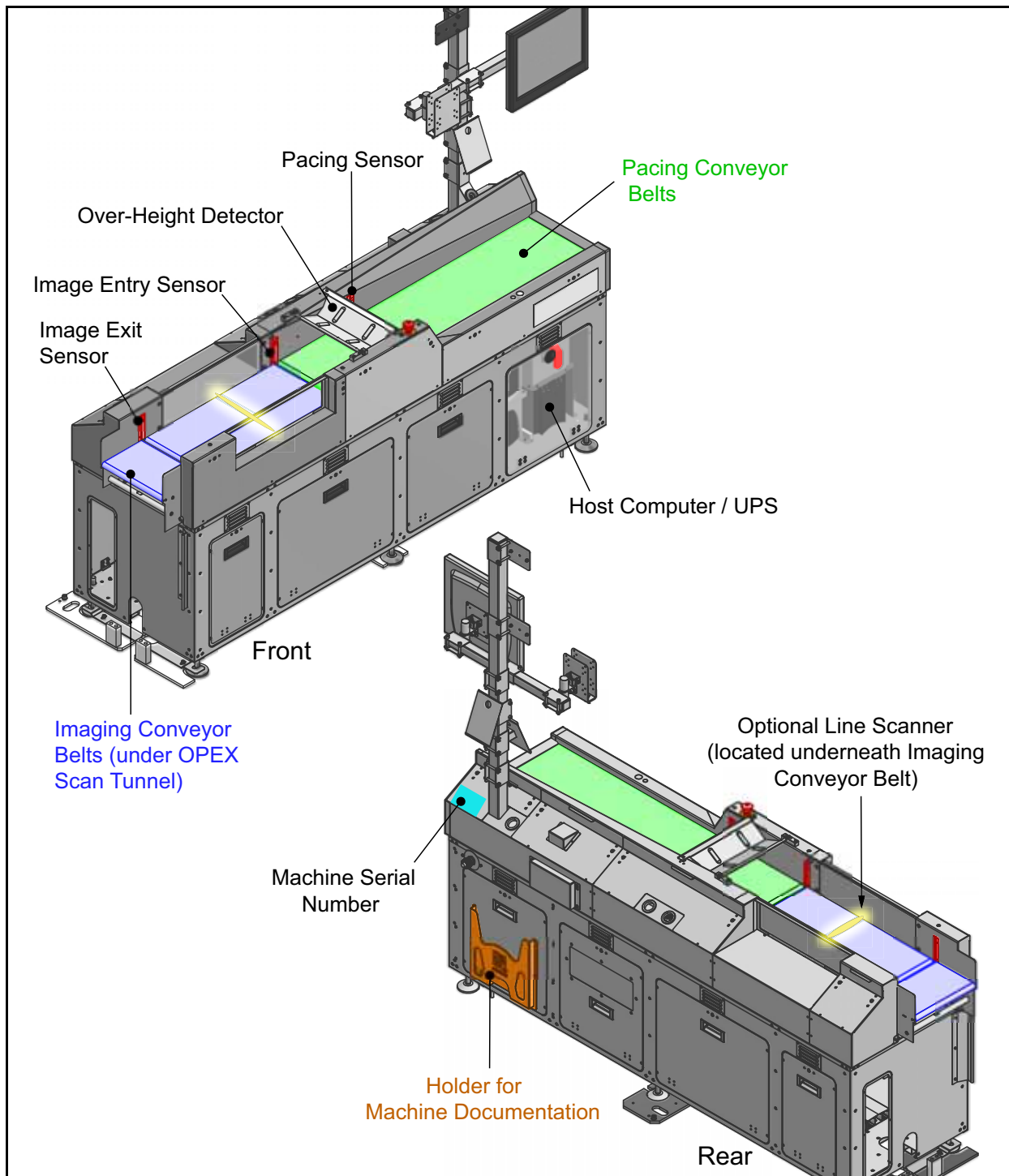

**Figure A-4: Right-Side Input Module - Key Components**

(This page is intentionally blank)



# G. Glossary

G.1. List of Acronyms ..... 170  
G.2. List of Terms..... 171

---

---

## G.1. List of Acronyms

---

---

The following list of acronyms, used throughout the Sure Sort documentation, is sorted alphabetically.

**API** - Application Programming Interface. A set of subroutine definitions, protocols, and tools for building application software. In general terms, it is a set of clearly defined methods of communication between various software components.

**ELC** - External Link Component. This software provides the link between the OPEX Host software and the customer's Warehouse Management System.

**RTC** - Real Time Controller

**UPS** - Uninterrupted Power Supply. A back up battery that supplies power in the event of a power loss.

**WMS** - Warehouse Management System. The WMS application supports the day-to-day operations in a warehouse. The WMS enables the management of tasks such as tracking inventory quantities and item locations.

**XCVR** - Transceiver

---

---

## G.2. List of Terms

---

---

The following list of terms, used throughout the Sure Sort documentation, is sorted alphabetically.

**Access Door** - Service door at the front and rear of the machine used by authorized personnel to enter the machine for maintenance or repairs.

**AC Distribution Enclosure** - This is the AC input module found in the input section above the UPS. This is the main AC input to the machine. This also contains the Lock out tag out feature for safely working on the machine. Only a qualified technician or authorized personnel should work within the machine.

**Back-End** - This is used as a reference to the customer's servers. Other common names may be warehouse management system (WMS), warehouse control system (WCS), or simply the customer's servers.

**Barcode** - This is the identifier on a package that is made up of a series of lines. These are read by the OPEX scan tunnel and/or optional barcode reader to identify the package.

**Base Module** - This is the first module in the aisle. It contains the iBOT charge rails and iBOT loader.

**Bin** - Bins, totes, or boxes are the terms used for the container in which the product gets delivered.

**Charge Control Board** - A printed circuit board located inside the loading column that distributes power to the main charge rail and auxiliary charge rails. This can hold as much as 50 amps of electricity and should only be handled by a qualified technician.

**Charging Power Supply** - Power source for the iBOT charge rails.

**Charge Rail** - Copper strips in the base module that provide power to the iBOTs. There can be as many as two charge rails: one in the front door and one auxiliary rail.

**Clear Path Motors** - Two motors used to control the pacing and imaging conveyors. Motors are powered and managed by a Clear Path power supply.

**Conveyor** - A mechanical assembly used for moving items from one place to another. Conveyors are located in three areas:

- In the input section, the conveyor is used to deliver the items to an available iBOT.
- Optional return conveyor, which sends items back to the operator for further processing.
- On an iBOT, the conveyor belt can move in either direction, making it very easy to support the double-sided expansion modules.

**E-Stop** - Short for “Emergency Stop,” a safety switch with a large, red button that stops the machine when pressed.

**Encoder** - Measuring device that tracks the speed of the conveyor.

**Expansion Module** - Add-on aisle sections that are attached to the base module to increase the number of delivery columns in the machine.

**Gate** - Switching levers in the iBOT track used to direct iBOTs into and out of vertical aisle columns.

**Gate Control Enclosure** - Houses electronics that trigger the gates to fire when required.

**Height Detector** - A metal plate and switch positioned above the pacing conveyor that prevents items that are too tall from entering the machine.

**Host** - Operator's main interface with the machine. The Host PC software interfaces with the INtime controller to manage system functions.

**iBOT** - Wireless robotic vehicles used to receive incoming items from the induct conveyor and deliver them to bins in the aisle.

**Image Entry Sensor** - A sensor on the input conveyor that communicates to the system through the I/O board that there is an object or package waiting to be picked up by an iBOT. It will allow the input conveyor to stop and start as needed.

**Induction** - The process of scanning an item one at a time, then placed onto the conveyor system to be inserted onto an iBOT; and once on the iBOT, sorted to the correct destination.

**Inductor** - Operator in charge of placing items onto the induction belt.

**Input Conveyor Module** - Section where the packages are dropped, scanned and timed to wait for the next iBOT to pick up.

**Interlock** - A safety device that shuts the system down when tripped. The front and rear access doors use Interlocks to stop the machine when either door handle is lifted.

**Jam** - A problem with the system, typically (but not always) caused by a blockage.

**Job** - A collection of the settings and methods the system will use to process items in a similar fashion from run to run. In many cases, you will only see one job, which should be set up ahead of time, either by an OPEX technician or your site supervisor or IT department.

**Lock-Out /Tag-Out (LOTO)** - A safety procedure to ensure that a machine is properly shut down and cannot be started up again while personnel are working on the machine. During LOTO, authorized personnel apply locking devices and warning tags to the power control switches, power cord plug, or main electrical disconnect to the machine. LOTO devices and warning tags may only be removed by authorized personnel, once they determine work is complete and the machine is safe to operate.

**Manager** - Person who creates operators and has access to most of the machine's controls and features.

**Menu Bar** - Vertical series of menus on the left side of the screen. Use the Menu Bar to navigate through the various system parameters and utilities.

**Operator** - The person running the machine. Operators have very limited access to system controls and settings.

**OPEX Scan Tunnel** - The Barcode system tunnel that reads the barcodes on the packages.

**Pacing Sensor** - This sensor resides on the pacing conveyor section before the imager entry sensor. If the imager entry sensor is detecting an object waiting for an iBOT, the pacing sensor will stop the pacing conveyor belts until the previous object has been sent. This avoids packages bunching up on one another and allows the system to send one object at a time.

**Pack-To-Light System** - The Pack-to-Light (PTL) feature consists of a series of lights that can be configured to indicate bin status. Some examples are: when/where there is a jam, bin is full, the order is complete.

**Path Sensor** - Used to provide feedback as to the location of an item in the system.

**Reject Bin** - This bin is on the opposite side of the input module. This is where items end up when they are rejected. These items are considered machine rejects, for reasons such as: too long, jam sorts, or gap too small.

**Return Conveyor** - Optional equipment used to return a rejected item back to the operator. Items that come back are mostly items that were not scanned properly. The return conveyor is motorized and moves items with a conveyor belt.

**Sweeper** - Operator in charge of emptying bins once they are full, or when an order is complete. The sweeper may also be responsible for clearing 'Failing to Unload' and 'Bin Blocked' scenarios.

**Traffic Controller** - A layer of system software acting as the central coordinator for the OPEX wireless network.

**Transceiver** - Device for sending and receiving wireless communication. Each iBOT has its own transceiver for communicating with main transceivers located in the base and expansion modules.

**Ultracapacitors** - Bank of high-energy capacitors that provide iBOT power. Ultracapacitors get recharged every time an iBOT returns to the charge rail.

---

---

## About OPEX Corporation

---

---

OPEX Corporation is more than a manufacturer of machines. We continuously reimagine technology to power the future for our customers.

With an innovative approach, we engineer unique automated solutions that support our customers so they can solve the most pressing business challenges for both today and tomorrow. Our scalable Warehouse, Document, and Mail Automation solutions improve workflow, accelerate change, and drive efficiencies in infrastructure.

We are a family-owned and operated organization with more than 1200 committed employees who innovate, manufacture, install, and service products that are helping transform industry every day. We listen to our customers, respect each other, and work together to help reimagine the future through automated solutions.

At OPEX, we are Next Generation Automation.



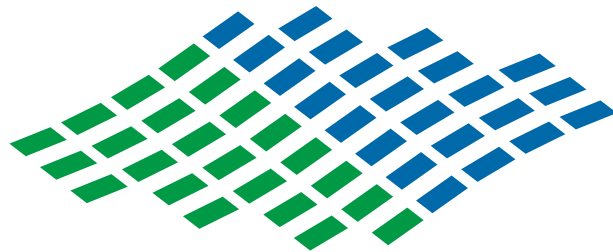

Sure Sort™

OPEX®